

*An Online CPD Course
brought to you by
CEDengineering.ca*

Fundamentals of Fluid Power

Course No: M04-050

Credit: 4 PDH

Elie Tawil, P.E., LEED AP

CED CANADA
engineering.ca
CPD FOR THE PROFESSIONAL

Continuing Education and Development, Inc.

P: (877) 322-5800

info@cedengineering.ca

This course was adapted from the Naval Education and Training Professional Development and Technology Center, Publication No. NAVEDTRA 14105A, “Fluid Power”, which is in the public domain.

CHAPTER 1

INTRODUCTION TO FLUID POWER

Fluid power is a term that describes the generation, control, and application of smooth, effective power of pumped or compressed fluids (either liquids or gases) to provide force and motion to mechanisms. This force and motion may be in the form of pushing, pulling, rotating, regulating, or driving. Fluid power includes hydraulics and pneumatics, which involve liquids and gases, respectively.

LEARNING OBJECTIVES

When you have completed this chapter, you will be able to do the following:

1. Recognize fundamentals of fluid power.
2. Explain the concept and history of hydraulics and pneumatics.
3. Identify the states of matter and the factors affecting them.

FLUID POWER

Advantages of Fluid Power

The extensive use of hydraulics and pneumatics to transmit power is due to the fact that properly constructed fluid power systems possess a number of favorable characteristics. They eliminate the need for complicated systems of gears, cams, and levers. Motion can be transmitted without the slack inherent in the use of solid machine parts. The fluids used are not subject to breakage as are mechanical parts, and the mechanisms are not subjected to great wear.

The different parts of a fluid power system can be conveniently located at widely separated points because the forces generated are rapidly transmitted over considerable distances with small loss. These forces can be conveyed up and down or around corners with small loss in efficiency and without complicated mechanisms. Very large forces can be controlled by much smaller ones and can be transmitted through comparatively small lines and orifices.

If the system is well adapted to the work it is required to perform, and if it is not misused, it can provide smooth, flexible, uniform action without vibration, and is unaffected by variation of load. In case of an overload, an automatic release of pressure can be guaranteed so that the system is protected against breakdown or strain. Fluid power systems can provide widely variable motions in both rotary and straight-line transmission of power. The need for control by hand can be minimized. In addition, fluid power systems are economical to operate.

The question may arise as to why hydraulics is used in some applications and pneumatics in others. Many factors are considered by the user and/or the manufacturer to determine which type of system to use in a specific application. There are no hard and fast rules to follow; however, past experience has provided some sound ideas that are usually considered when such decisions are made. If the application requires speed, a medium amount of pressure, and only fairly accurate control, a pneumatic system may be used. If the application requires only a medium amount of pressure and more accurate control, a combination of hydraulics and pneumatics may be used. If the application requires a great amount of pressure and/or extremely accurate control, a hydraulic system should be used.

Special Problems

The extreme flexibility of fluid power elements presents a number of problems. Because fluids have no shape of their own, they must be positively confined throughout the entire system. Special consideration must be given to the structural integrity of the parts of a fluid power system. Strong pipes and containers must be provided. Leaks, which are a serious problem with the high pressure obtained in many fluid power installations, must be prevented.

The operation of the system involves constant movement of the fluid within the lines and components. This movement causes friction within the fluid itself and against the containing surfaces, which, if excessive, can lead to serious losses in efficiency. Foreign matter must not be allowed to accumulate in the system, where it will clog small passages or score closely fitted parts. Chemical action may cause corrosion. Anyone working with fluid power systems must know how a fluid power system and its components operate, in terms of both the general principles common to all physical mechanisms and of the peculiarities of the particular arrangement at hand.

HYDRAULICS

The word hydraulics is based on the Greek word for water, and originally covered the study of the physical behavior of water at rest and in motion. Use has broadened its meaning to include the behavior of all liquids, although it is primarily concerned with the motion of liquids.

Hydraulics includes the manner in which liquids act in tanks and pipes, deals with their properties, and explores ways to take advantage of these properties.

Development of Hydraulics

Although the modern development of hydraulics is comparatively recent, the ancients were familiar with many hydraulic principles and their applications. The Egyptians and the ancient people of Persia, India, and China conveyed water along channels for irrigation and domestic purposes, using dams and sluice gates to control the flow. The ancient Cretans had an elaborate plumbing system. Archimedes studied the laws of floating and submerged bodies. The Romans constructed aqueducts to carry water to their cities.

After the breakup of the ancient world, there were few new developments for many centuries. Then, over a comparatively short period, beginning near the end of the 17th century, Italian physicist Evangelista Torricelle, French physicist Edme Mariotte, and later Swiss physicist Daniel Bernoulli conducted experiments to study the elements of force in the discharge of water through small openings in the sides of tanks and through short pipes. During the same period, Blaise Pascal, a French scientist, discovered the fundamental law for the science of hydraulics.

Pascal's law states that an increase in pressure on the surface of a confined fluid is transmitted undiminished throughout the confining vessel or system (*Figure 1-1*).

For Pascal's law to be made effective for practical applications, it was necessary to have a piston that "fit exactly." It was not until the latter part of the 18th century that methods were found to make these snugly fitted parts required in hydraulic systems. This manufacturing of parts was accomplished by the invention of machines that were used to cut and shape the necessary closely fitted parts and, particularly, by the development of gaskets and packings. Since that time, components such as valves, pumps, actuating cylinders, and motors have been developed and refined to make hydraulics one of the leading methods of transmitting power.

Use of Hydraulics

Today, hydraulic power is used to operate many different tools and mechanisms. In a garage, a mechanic raises the end of an automobile with a hydraulic jack. Dentists and barbers use hydraulic power, through a few strokes of a control lever, to lift and position their chairs to a convenient working height. Hydraulic doorstops keep heavy doors from slamming. Hydraulic brakes have been standard equipment on automobiles since the 1930s. Most automobiles are equipped with automatic transmissions that are hydraulically operated. Power steering is another application of hydraulic power. Construction workers depend upon hydraulic power for the operation of various components of their equipment. For example, the blade of a bulldozer is normally operated by hydraulic power.

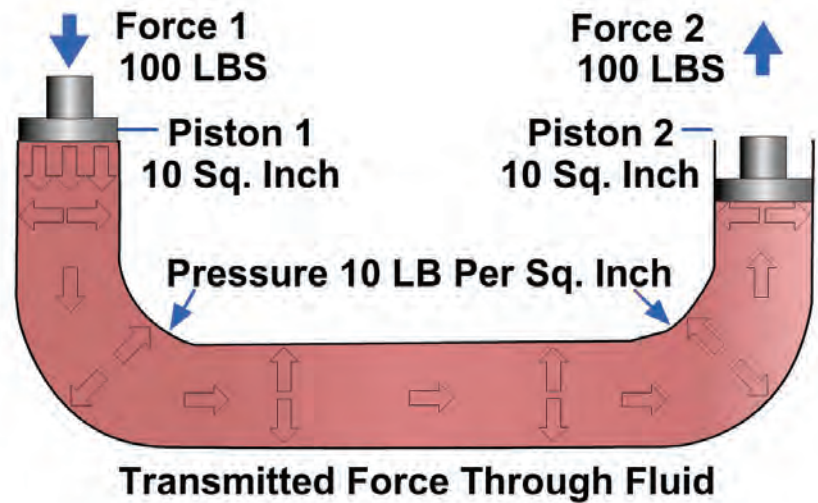

Figure 1-1 — Force transmitted through fluid.

During the period preceding World War II, the Navy began to apply hydraulics to naval mechanisms extensively. Since then, naval applications have increased to the point where many ingenious hydraulic devices are used in the solution of problems of gunnery, aeronautics, and navigation. Aboard ship, hydraulic power is used to operate such equipment as anchor windlasses, cranes, steering gear, remote control devices, and power drives for elevating and training guns and rocket launchers. Elevators on aircraft carriers use hydraulic power to transfer aircraft from the hangar deck to the flight deck and vice versa.

Hydraulics and pneumatics are combined for some applications. This combination is referred to as hydropneumatics. An example of this combination is equipment and machinery associated with underway replenishment (UNREP) systems and aircraft elevator systems. Air pressure is applied to the surface of hydraulic fluid in a reservoir. The air pressure forces the hydraulic fluid to raise the lift.

STATES OF MATTER

The material that makes up the universe is known as matter. Matter is defined as any substance that occupies space and has weight.

Matter exists in three states: solid, liquid, and gas; each has distinguishing characteristics. Solids have a definite volume and a definite shape; liquids have a definite volume but take the shape of their containing vessels; gases have neither a definite shape nor a definite volume. Gases not only take the shape of the containing vessel but also expand and fill the vessel, regardless of its volume. Examples of the states of matter are iron, water, and air.

Matter can change from one state to another. Water is a good example. At high temperatures it is in the gaseous state known as steam. At moderate temperatures it is a liquid, and at low temperatures it

becomes ice, which is definitely a solid state. In this example, the temperature is the dominant factor in determining the state the substance assumes.

Pressure is another important factor that will effect changes in the state of matter. At pressures lower than atmospheric pressure, water will boil and thus change into steam at temperatures lower than 212 degrees Fahrenheit (°F). Pressure is also a critical factor in changing some gases to liquids or solids. Normally, when pressure and chilling are both applied to a gas, the gas assumes a liquid state. Liquid air, which is a mixture of oxygen and nitrogen, is produced in this manner.

In the study of fluid power, we are concerned primarily with the properties and characteristics of liquids and gases. However, you should keep in mind that the properties of solids also affect the characteristics of liquids and gases. The lines and components, which are solids, enclose and control the liquid or gas in their respective systems.

Additional Resources and References:

Airman, NAVEDTRA 14014A, Center for Naval Aviation Technical Training (CNATT), Pensacola, FL, December 2012.

Construction Mechanic Basic, NAVEDTRA 14264A, Center for Seabees and Facilities Engineering (CSFE), Port Hueneme, CA, October 2010.

Machinist's Mate (Surface), NAVEDTRA 14150A, Surface Warfare Officers School (SWOS), Newport, RI, September 2013.

CHAPTER 2

FORCES IN LIQUIDS

The study of liquids is divided into two main parts: liquids at rest (hydrostatics) and liquids in motion (hydraulics).

The effects of liquids at rest can often be expressed by simple formulas. The effects of liquids in motion are more difficult to express due to frictional and other factors whose actions cannot be expressed by simple mathematics.

In chapter 1 we learned that liquids have a definite volume but take the shape of their containing vessel. There are two additional characteristics we must explore prior to proceeding.

Liquids are almost incompressible. For example, if a pressure of 100 pounds per square inch (psi) is applied to a given volume of water that is at atmospheric pressure, the volume will decrease by only 0.03 percent. It would take a force of approximately 32 tons to reduce its volume by 10 percent; however, when this force is removed, the water immediately returns to its original volume. Other liquids behave in about the same manner as water.

Another characteristic of a liquid is the tendency to keep its free surface level. If the surface is not level, liquids will flow in the direction that will tend to make the surface level.

LEARNING OBJECTIVES

When you have completed this chapter, you will be able to do the following:

1. Recognize the pressure characteristics of liquids.
2. Describe how pressure is caused by the weight of the atmosphere.
3. Explain how pressures are measured.
4. Identify terms and facts applicable to the physics of fluids.
5. Solve problems pertaining to density and specific gravity.
6. Recognize the principles and equations involved with the transmission of forces.
7. Solve problems and equations involved with the transmission of forces.
8. Recognize the characteristics and behavior of fluids in motion.
9. Explain the methods for measuring volume and velocity.
10. Relate the dynamic and static factors involved with fluid flow.
11. Describe the operating characteristics and component functions of basic fluid power systems.

LIQUIDS AT REST

A Substance confined in an enclosed container at rest, situated on a fixed part of earth's surface. In studying fluids at rest, we are concerned with the transmission of force and the factors that affect the forces in liquids. Additionally, pressure in and on liquids and factors affecting pressure are of great importance.

Pressure and Force

The terms force and pressure are used extensively in the study of fluid power. It is essential that we distinguish between the terms. Force means a total push or pull. It is the push or pull exerted against the total area of a particular surface and is expressed in pounds or grams. Pressure means the amount of push or pull (force) applied to each unit area of the surface and is expressed in pounds per square inch (lb/in²) or grams per square centimeter (g/cm²). Pressure maybe exerted in one direction, in several directions, or in all directions.

Computing Force, Pressure, and Area

A formula is used in computing force, pressure, and area in fluid power systems. In these formulas, P refers to pressure, F indicates force, and A represents area.

$$\text{Force}_{(LBS)} = \text{Pressure}_{(PSI)} \times \text{Area}_{(IN^2)}$$

Force equals pressure times area. Thus, the formula is written:

$$\text{Equation 2-1: } F = P \times A$$

Pressure equals force divided by area. By rearranging the formula, this statement may be condensed into:

$$\text{Equation 2-2: } P = \frac{F}{A}$$

Since area equals force divided by pressure, the formula is written:

$$\text{Equation 2-3: } A = \frac{F}{P}$$

A memory device for recalling the different variations of this formula is shown in *Figure 2-1*. Any letter in the triangle may be expressed as the product or quotient of the other two, depending on its position within the triangle.

To determine the area, use the formula for finding the area of a circle. This is written $A = \pi r^2$ where A is the area, 3.1416 (3.14 or 3 1/7 for most calculations), and r^2 indicates the radius squared. $A = \pi r^2$

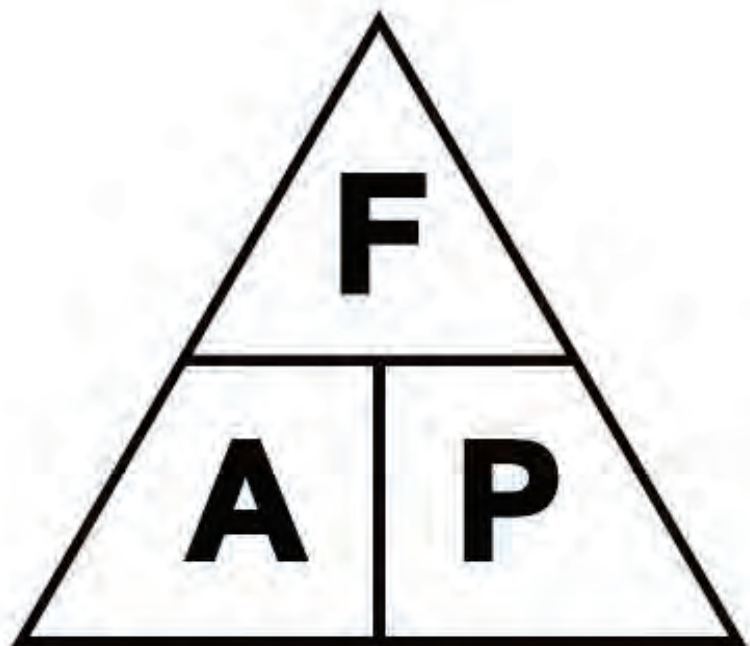

Figure 2-1 — Device for determining the arrangement of the force, pressure, and area formula.

NOTE

Sometimes the area may not be expressed in square units. If the surface is rectangular, you can determine its area by multiplying its length (say, in inches) by its width (also in inches). The majority of areas you will consider in these calculations are circular in shape. Either the radius or the diameter may be given, but you must know the radius in inches to find the area. The radius is one-half the diameter.

Atmospheric Pressure

The atmosphere is the entire mass of air that surrounds the earth. While it extends upward for about 500 miles, the section of primary interest is the portion that rests on the earth's surface and extends upward for about 7 1/2 miles. This layer is called the troposphere.

If a column of air 1-inch square extending all the way to the "top" of the atmosphere could be weighed, this column of air would weigh approximately 14.7 pounds at sea level. Thus, atmospheric pressure at sea level is approximately 14.7 psi.

As one ascends, the atmospheric pressure decreases by approximately 1.0 psi for every 2,343 feet. However, below sea level, in excavations and depressions, atmospheric pressure increases. Pressures under water differ from those under air only because the weight of the water must be added to the pressure of the air.

Atmospheric pressure can be measured by any of several methods. The common laboratory method uses the mercury column barometer. The height of the mercury column serves as an indicator of atmospheric pressure. At sea level and at a temperature of 0 degrees Celsius ($^{\circ}\text{C}$), the height of the mercury column is approximately 30 inches, or 76 centimeters. This represents a pressure of approximately 14.7 psi. The 30-inch column is used as a reference standard.

Another device used to measure atmospheric pressure is the aneroid barometer. The aneroid barometer uses the change in shape of an evacuated metal cell to measure variations in atmospheric pressure (*Figure 2-2*). The thin metal of the aneroid cell moves in or out with the variation of pressure on its external surface. This movement is transmitted through a system of levers to a pointer, which indicates the pressure.

The atmospheric pressure does not vary uniformly with altitude. It changes more rapidly at lower altitudes because of the compressibility of the air, which causes the air layers close to the earth's surface to be compressed by the air masses above them. This effect, however, is partially counteracted by the contraction of the upper layers due to cooling. The cooling tends to increase the density of the air.

Atmospheric pressures are quite large, but in most instances practically the same pressure is present on all sides of objects so that no single surface is subjected to a great load.

Atmospheric pressure acting on the surface of a liquid (*Figure 2-3, view A*) is transmitted equally throughout the liquid to the walls of the container, but is balanced by the same atmospheric pressure acting on the outer walls of the container. Atmospheric pressure acting on the surface of one piston is balanced (*Figure 2-3, view B*) by the same pressure acting on the surface of the other piston. The different areas of the two surfaces make no difference, since for a unit of area, pressures are balanced.

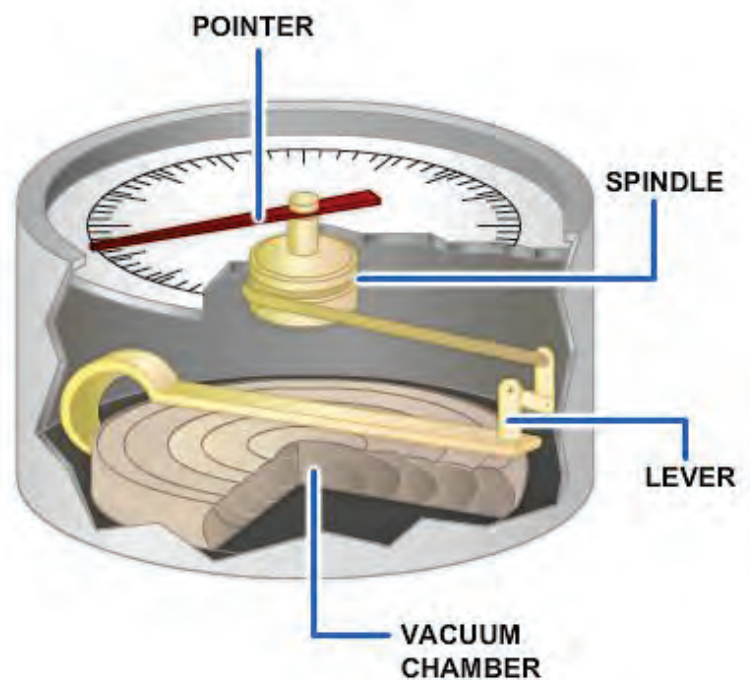

Figure 2-2 — Simple diagram of the aneroid barometer.

TRANSMISSION OF FORCES THROUGH LIQUIDS

When the end of a solid bar is struck, the main force of the blow is carried straight through the bar to the other end (*Figure 2-4, view A*). This happens because the bar is rigid. The direction of the blow almost entirely determines the direction of the transmitted force. The more rigid the bar, the less force is lost inside the bar or transmitted outward at right angles to the direction of the blow.

When a force is applied to the end of a column of confined liquid (*Figure 2-4, view B*), it is transmitted straight through to the other end and also equally and undiminished in every direction throughout the column—forward, backward, and sideways—so that the containing vessel is literally filled with pressure.

An example of this distribution of force is illustrated in *Figure 2-5*. The flat hose takes on a circular cross section when it is filled with water under pressure. The outward push of the water is equal in every direction.

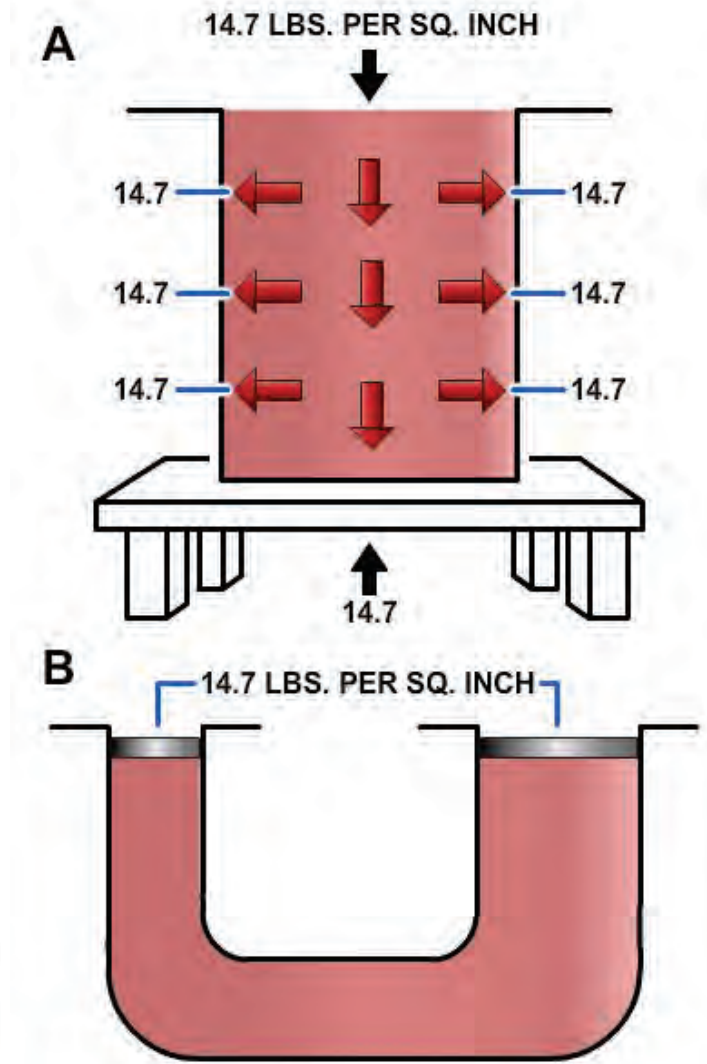

Figure 2-3 — Effects of atmospheric pressure.

So far we have explained the effects of atmospheric pressure on liquids and how external forces are distributed through liquids. Let us now focus our attention on forces generated by the weight of liquids themselves. To do this, we must first discuss density, specific gravity, and Pascal's law.

Density and Specific Gravity

The density of a substance is its weight per unit volume. The unit volume in the English system of measurement is 1 cubic foot. In the metric system it is the cubic centimeter; therefore, density is expressed in pounds per cubic foot or in grams per cubic centimeter.

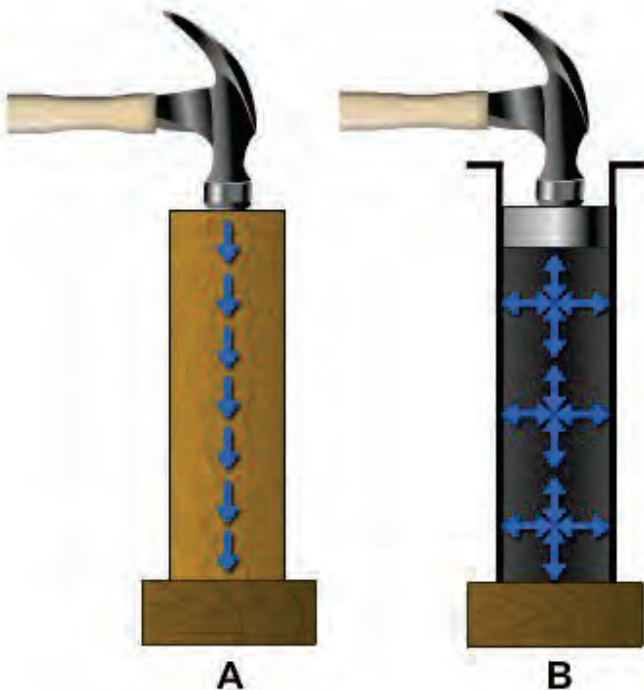

Figure 2-4 — Transmission of force: (A) solid; (B) fluid.

To find the density (D) of a substance, you must know its weight (W) and volume (V). You then divide its weight by its volume to find the weight per unit volume. In equation form, this is written as:

Equation 2-4: $D = W/V$

EXAMPLE: The liquid that fills a certain container weighs 1,497.6 pounds. The container is 4 feet long, 3 feet wide, and 2 feet deep. Its volume is 24 cubic feet (4 ft x 3 ft x 2 ft). If 24 cubic feet of this liquid weighs 1,497.6 pounds, then 1 cubic foot weighs 62.4.

$$\frac{1,497.6}{24} = 62.4$$

Therefore, the density of the liquid is 62.4 pounds per cubic foot.

This is the density of water at 4 °C and is usually used as the standard for comparing densities of other substances. The temperature of 4 °C was selected because water has its maximum density at this temperature. In the metric system, the density of water is 1 gram per cubic centimeter. The standard temperature of 4 °C is used whenever the density of liquids and solids is measured. Changes in temperature will not change the weight of a substance but will change the volume of the substance by expansion or contraction, thus changing the weight per unit volume.

In physics, the word specific implies a ratio. Weight is the measure of the earth’s attraction for a body. The earth’s attraction for a body is called gravity. Thus, the ratio of the weight of a unit volume of some substance to the weight of an equal volume of a standard substance, measured under standard pressure and temperature conditions, is called specific gravity. The terms specific weight and specific density are sometimes used to express this ratio.

The following formulas are used to find the specific gravity (sp gr) of solids and liquids, with water used as the standard substance.

$$sp\ gr = \frac{\textit{Weight of the substance}}{\textit{Weight of an equal volume of water}}$$

or,

$$sp\ gr = \frac{\textit{Density of the substance}}{\textit{Density of water}}$$

The same formulas are used to find the specific gravity of gases by substituting air, oxygen, or hydrogen for water.

The specific gravity of water is $1, \frac{62.4}{62.4}$.

If a cubic foot of a certain liquid weighs 68.64 pounds, then its specific gravity is $1.1, \frac{68.64}{62.4}$.



Figure 2-5 — Distribution of force.

Thus, the specific gravity of the liquid is the ratio of its density to the density of water. If the specific gravity of a liquid or solid is known, the density of the liquid or solid may be obtained by multiplying its specific gravity by the density of water. For example, if a certain hydraulic liquid has a specific gravity of 0.8, 1 cubic foot of the liquid weighs 0.8 times as much as a cubic foot of water—0.8 times 62.4, or 49.92 pounds. In the metric system, 1 cubic centimeter of a substance with a specific gravity of 0.8 weighs 1 times 0.8, or 0.8 grams. (Note that in the metric system the specific gravity of a liquid or solid has the same numerical value as its density, because water weighs 1 gram per cubic centimeter.)

Specific gravity and density are independent of the size of the sample under consideration and depend only on the substance of which it is made.

A device called a hydrometer is used for measuring the specific gravity of liquids.

Pascal's Law

Recall from chapter 1 that the foundation of modern hydraulics was established when Pascal discovered that pressure in a fluid acts equally in all directions. This pressure acts at right angles to the containing surfaces. If some type of pressure gauge, with an exposed face, is placed beneath the surface of a liquid (*Figure 2-6*) at a specific depth and pointed in different directions, the pressure will read the same. Thus, we can say that pressure in a liquid is independent of direction.

Pressure due to the weight of a liquid, at any level, depends on the depth of the fluid from the surface. If the exposed face of the pressure gauges (*Figure 2-6*) is moved closer to the surface of the liquid, the indicated pressure will be less. When the depth is doubled, the indicated pressure is doubled. Thus the pressure in a liquid is directly proportional to the depth.

Consider a container with vertical sides (*Figure 2-7*) that is 1 foot long and 1 foot wide. Let it be filled with water 1 foot deep, providing 1 cubic foot of water. We learned earlier in this chapter

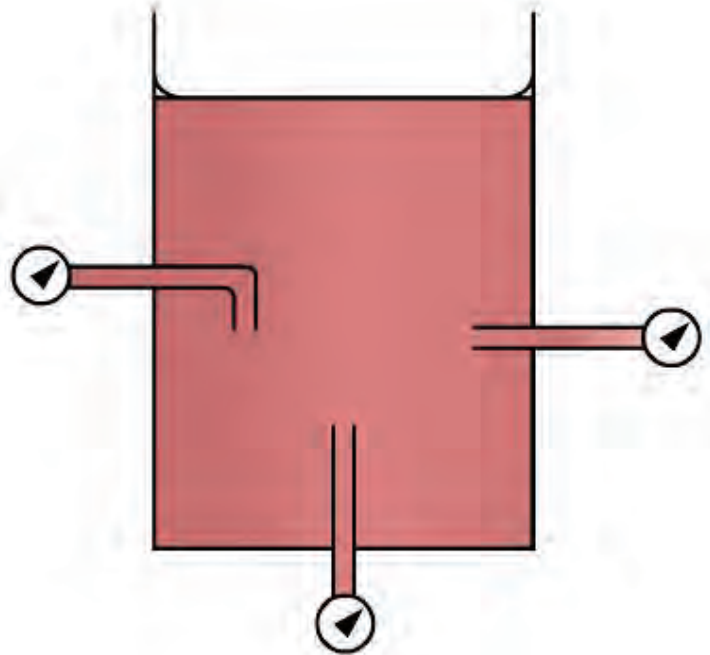

Figure 2-6 — Pressure of a liquid is independent of direction.

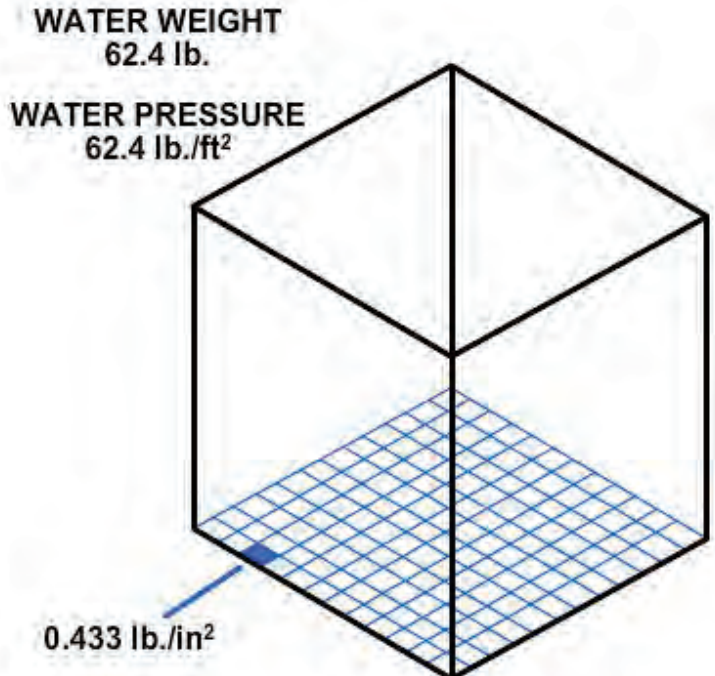

Figure 2-7 — Water pressure in a 1-cubic-foot container.

that 1 cubic foot of water weighs 62.4 pounds. Using this information and equation 2-2, $P = \frac{F}{A}$, we can calculate the pressure on the bottom of the container.

$$\begin{aligned} P &= \frac{F}{A} \\ &= \frac{62.4 \text{ lbs}}{1 \text{ ft}^2} \\ &= 62.4 \text{ lb/ft}^2 \end{aligned}$$

Since there are 144 square inches in 1 square foot,

$$P_{(PSI)} = \frac{62.4 \text{ lbs}}{144 \text{ in}^2} = 0.433 \text{ PSI}$$

This equation can be stated as follows: the weight of a column of water 1 foot high, having a cross-sectional area of 1 square inch, is 0.433 pound.

If the depth of the column is tripled, the weight of the column will be 3×0.433 , or 1.299 pounds, and the pressure at the bottom will be 1.299 (psi), since pressure equals the force divided by the area. Thus, the pressure at any depth in a liquid is equal to the weight of the column of liquid at that depth divided by the cross-sectional area of the column at that depth. The volume of a liquid that produces the pressure is referred to as the fluid head of the liquid. The pressure of a liquid due to its fluid head is also dependent on the density of the liquid.

If we let A equal any cross-sectional area of a liquid column and h equal the depth of the column, the volume becomes Ah . Using equation 2-4, $D = W/V$, the weight of the liquid above area A is equal to AhD .

$$D = W/V, D = \frac{W}{Ah}, W = AhD$$

Since pressure is equal to the force per unit area, set A equal to 1. Then the formula pressure becomes

$$\text{Equation 2-5: } P = hD$$

It is essential that h and D be expressed in similar units. That is, if D is expressed in pounds per cubic foot, the value of h must be expressed in feet. If the desired pressure is to be expressed in pounds per square inch, the pressure formula, equation 2-5, becomes

$$\text{Equation 2-6: } P = \frac{hD}{144}$$

Pascal was also the first to prove by experiment that the shape and volume of a container in no way alters pressure. Thus in *Figure 2-8*, if the pressure due to the weight of the liquid at a point on horizontal line

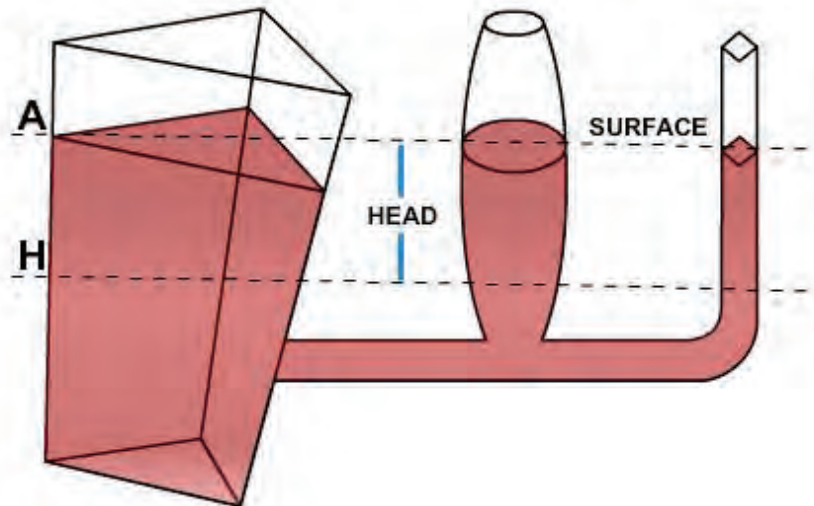

Figure 2-8 — Pressure relationship with shape.

H is 8 psi, the pressure is 8 psi everywhere at level H in the system. Equation 2-5 also shows that the pressure is independent of the shape and volume of a container.

Pressure and Force in Fluid Power Systems

Recall that, according to Pascal's law, any force applied to a confined fluid is transmitted in all directions throughout the fluid regardless of the shape of the container. Consider the effect of this in the system shown in *Figure 2-9*. If there is a resistance on the the output piston and the input piston is pushed downward, a pressure is created through the fluid, which acts equally at right angles to surfaces in all parts of the container.

If force 1 is 100 pounds and the area of the input piston is 10 square inches, then the pressure in the fluid is 10 psi:

$$\frac{100 \text{ lb}}{10 \text{ (in}^2\text{)}}$$

NOTE

Fluid pressure cannot be created without resistance to flow. In this case, resistance is provided by the equipment to which the output piston is attached. The force of resistance acts against the top of the output piston. The pressure created in the system by the input piston pushes on the underside of the output piston with a force of 10 pounds on each square inch.

In this case, the fluid column has a uniform cross section, so the area of the output piston is the same as the area of the input piston, or 10 square inches. Therefore, the upward force on the output piston is 100 pounds ($10 \text{ psi} \times 10 \text{ in}^2$), the same as the force applied to the input piston. All that was accomplished in this system was to transmit the 100-pound force around the bend. However, this principle underlies practically all mechanical applications of fluid power.

At this point you should note that since Pascal's law is independent of the shape of the container, it is not necessary that the tube connecting the two pistons have the same cross-sectional area of the pistons. A connection of any size, shape, or length will do, as long as an unobstructed passage is provided. Therefore, the system

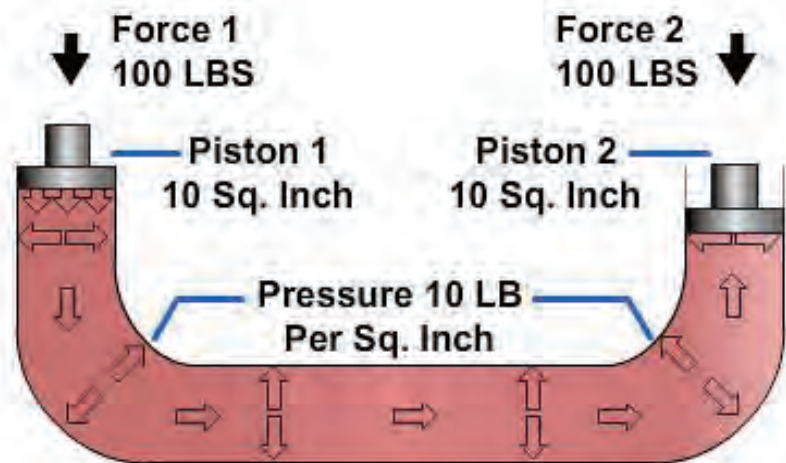

Transmitted Force Through Fluid

Figure 2-9 — Force transmitted through fluid.

shown in *Figure 2-10*, with a relatively small, bent pipe connecting two cylinders, will act exactly the same as the system shown in *Figure 2-9*.

Multiplication of Forces

Consider the situation in *Figure 2-11*, where the input piston is much smaller than the output piston. Assume that the area of the input piston is 2 square inches. With a resistant force on the output piston, a downward force of 20 pounds acting on the input piston creates a pressure of 10 psi in the fluid. Although this force is much smaller than the force applied in *Figures 2-9 and 2-10*, the pressure is the same. This is because the force is applied to a smaller area.

This pressure of 10 psi acts on all parts of the fluid container, including the bottom of the output piston. The upward force on the output piston is 200 pounds (10 pounds of pressure on each square inch). In this case, the original force has been multiplied tenfold while using the same pressure in the fluid as before. In any system with these dimensions, the ratio of output force to input force is always 10 to 1, regardless of the applied force. For example, if the applied force of the input piston is 50 pounds, the pressure in the system will be 25 psi. This will support a resistant force of 500 pounds on the output piston.

The system works the same in reverse. If we change the applied force and place a 200-pound force on the output piston (*Figure 2-11*), making it the input piston, the output force on the input piston will be one-tenth the input force, or 20 pounds. (Sometimes such results are desired.) Therefore, if two pistons are used in a fluid power system, the force acting on each piston is directly proportional to its area, and the magnitude of each force is the product of the pressure and the area of each piston.

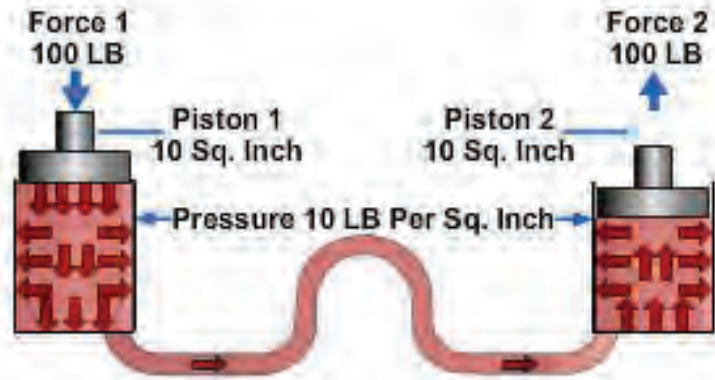

Transmitted Force Through Small Pipe

Figure 2-10 — Transmitting force through a small pipe.

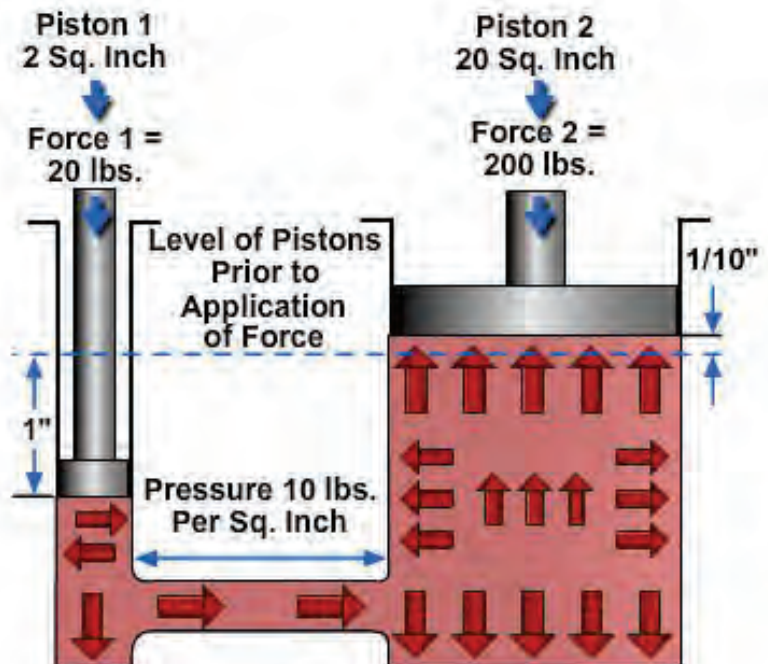

Figure 2-11 — Multiplication of forces.

Differential Areas

Consider the special situation shown in *Figure 2-12*. Here, a single piston (1) in a cylinder (2) has a piston rod (3) attached to one of its sides. The piston rod extends out of one end of the cylinder. Fluid under pressure is admitted equally to both ends of the cylinder. The opposed faces of the piston (1) behave like two pistons acting against each other. The area of one face is the full cross-sectional area of the cylinder, say 6 square inches, while the area of the other face is the area of the cylinder minus the area of the piston rod, which is 2 square inches. This leaves an effective area of 4 square inches on the right face of the piston. The pressure on both faces is the same, in this case, 20 psi. Recall that, according to Pascal's Law, a pressure exerted on a piston produces an equal increase in pressure on another piston in the system. If the second piston has an area 10 times that of the first, the force on the second piston is 10 times greater, though the pressure is the same as that on the first piston. This rule is shown in *Figure 2-12*, as the force pushing the piston to the right is its area times the pressure, or 120 pounds (20×6). Likewise, the force pushing the piston to the left is its area times the pressure, or 80 pounds (20×4). Therefore, there is a net unbalanced force of 40 pounds acting to the right, and the piston will move in that direction. The net effect is the same as if the piston and the cylinder had the same cross-sectional area as the piston rod.

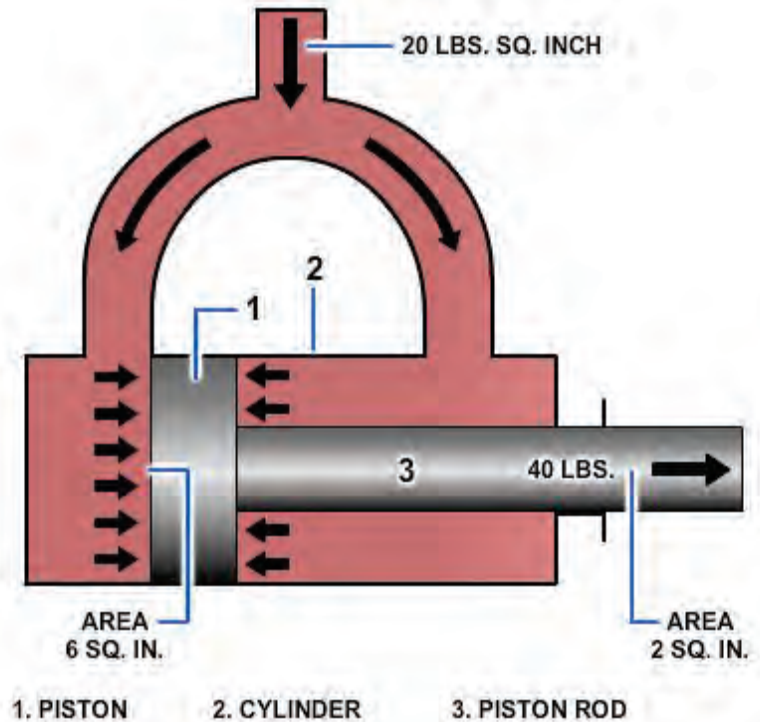

Figure 2-12 — Differential areas on a piston.

Volume and Distance Factors

You have learned that if a force is applied to a system and the cross-sectional areas of the input and output pistons are equal, as in *Figures 2-9 and 2-10*, the force on the input piston will support an equal resistant force on the output piston. The pressure of the liquid at this point is equal to the force applied to the input piston divided by the piston's area. Let us now look at what happens when a force greater than the resistance is applied to the input piston.

In the system illustrated in *Figure 2-9*, assume that the resistance force on the output piston is 100 psi. If a force slightly greater than 100 pounds is applied to the input piston, the pressure in the system will be slightly greater than 10 psi. This increase in pressure will overcome the resistance force on the output piston. Assume that the input piston is forced downward 1 inch. The movement displaces 10 cubic inches of fluid. The fluid must go somewhere. Since the system is closed and the fluid is practically incompressible, the fluid will move to the right side of the system. Because the output piston also has a cross-sectional area of 10 square inches, it will move 1 inch upward to accommodate the 10 cubic inches of fluid. You may generalize this by saying that if two pistons in a closed system have equal cross-sectional areas and one piston is pushed and moved, the other piston will move the same distance, though in the opposite direction. This is because a decrease in volume in one part of the system is balanced by one equal increase in volume in another part of the system.

Apply this reasoning to the system in *Figure 2-11*. If the input piston is pushed down a distance of 1 inch, the volume of fluid in the left cylinder will decrease by 2 cubic inches. At the same time, the volume in the right cylinder will increase by 2 cubic inches. Since the diameter of the right cylinder cannot change, the piston must move upward to allow the volume to increase. The piston will move a distance equal to the volume increase divided by the surface area of the piston (equal to the surface area of the cylinder). In this example, the piston will move one-tenth of an inch ($2 \text{ cu in} \div 20 \text{ in}^2$). This leads to the second basic rule for a fluid power system that contains two pistons: The distances the pistons move are inversely proportional to the areas of the pistons. Or more simply, if one piston is smaller than the other, the smaller piston must move a greater distance than the larger piston any time the pistons move.

LIQUIDS IN MOTION

In the operation of fluid power systems, there must be a flow of fluid. The amount of flow will vary from system to system. To understand fluid power systems in action, it is necessary to understand some of the characteristics of liquids in motion.

Liquids in motion have characteristics different from liquids at rest. Frictional resistances within a fluid (viscosity) and inertia contribute to these differences. (Viscosity is discussed in chapter 3.) *Inertia*, which means the resistance a mass offers to being set in motion, will be discussed later in this section. There are other relationships of liquids in motion with which you must become familiar. Among these is volume of flow (flow rate), velocity of flow (velocity of fluid), streamline (laminar) and, turbulent flow that occur in flow.

Volume and Velocity of Flow

The volume of a liquid passing a point in a given time is known as its volume of flow or flow rate. The volume of flow is usually expressed in gallons per minute (gpm) and is associated with relative pressures of the liquid, such as 5 gpm at 40 psi.

The velocity of flow or velocity of the fluid is defined as the average speed at which the fluid moves past a given point. It is usually expressed in feet per second (fps) or feet per minute (fpm). Velocity of flow is an important consideration in sizing the hydraulic lines.

Volume and velocity of flow are often considered together. With other conditions unaltered—that is, with volume of input unchanged—the velocity of flow increases as the cross section or size of the pipe decreases, and the velocity of flow decreases as the cross section increases. For example, the velocity of flow is slow at wide parts of a stream and rapid at narrow parts, yet the volume of water passing each part of the stream is the same.

In *Figure 2-13*, if the cross-sectional area of the pipe is 16 square inches at point A and 4 square inches at point B, we can calculate the relative velocity of flow using the flow equation

$$\text{Equation 2-7 } Q = vA$$

where Q is the volume of flow, v is the velocity of flow, and A is the cross-sectional area of the liquid. Since the volume of flow at point A, Q_1 , is equal to the volume of flow at point B, Q_2 , we can use equation 2-7 to determine the ratio of the velocity of flow at point A, v_1 , to the velocity of flow at point B, v_2 .

$$\text{Since } Q_1 = Q_2, A_1 v_1 = A_2 v_2$$

$$\text{From Figure 2-13; } A_1 = 16 \text{ in}^2, A_2 = 4 \text{ in}^2$$

$$\text{Substituting: } 16v_1 = 4v_2 \text{ or } v_2 = 4v_1$$

Therefore, the velocity of flow at point B is four times the velocity of flow at point A.

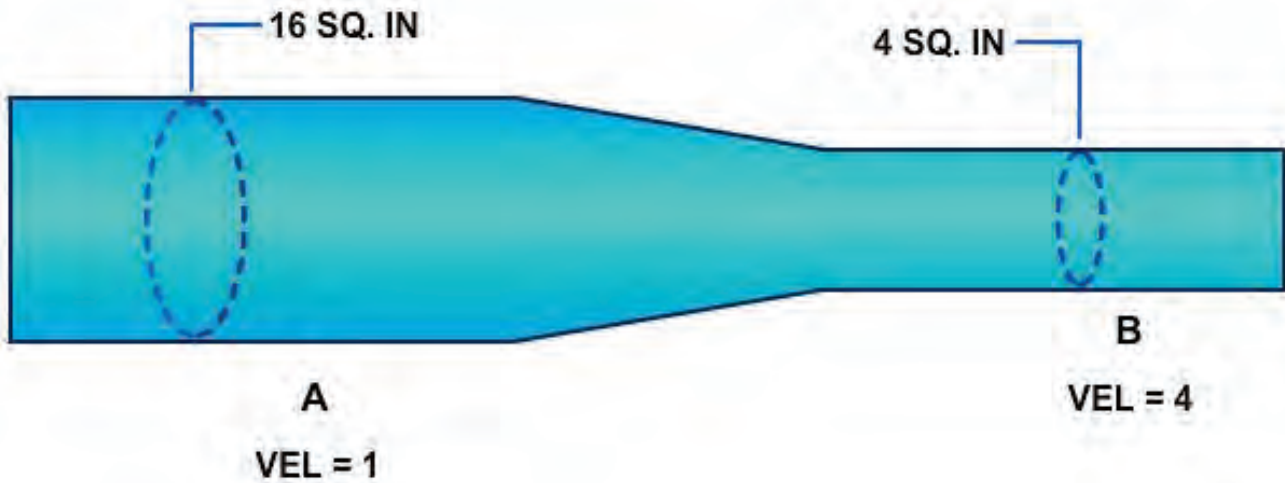

Figure 2-13 — Volume and velocity of flow.

Volume of Flow and Speed

If you consider the cylinder volume you must fill and the distance the piston must travel, you can relate the volume of flow to the speed of the piston. The volume of the cylinder is found by multiplying the piston area by the length the piston must travel (stroke).

Suppose you have determined that two cylinders have the same volume and that one cylinder is twice as long as the other. In this case, the cross-sectional area of the longer tube will be half of the cross-sectional area of the other tube. If fluid is pumped into each cylinder at the same rate, both pistons will reach their full travel at the same time. However, the piston in the longer cylinder must travel twice as fast because it has twice as far to go.

There are two ways of controlling the speed of the piston: (1) by varying the size of the cylinder and (2) by varying the volume of flow (gpm) to the cylinders. (Hydraulic cylinders are discussed in detail in chapter 10.)

Streamline and Turbulent Flow

At low velocities or in tubes of small diameter, flow is streamlined. This means that a given particle of fluid moves straight forward without bumping into other particles and without crossing their paths. Streamline flow is often referred to as laminar flow, which is defined as a flow situation in which fluid moves in parallel laminae or layers. As an example of streamline flow, consider *Figure 2-14*, which illustrates an open stream flowing at a slow, uniform rate.

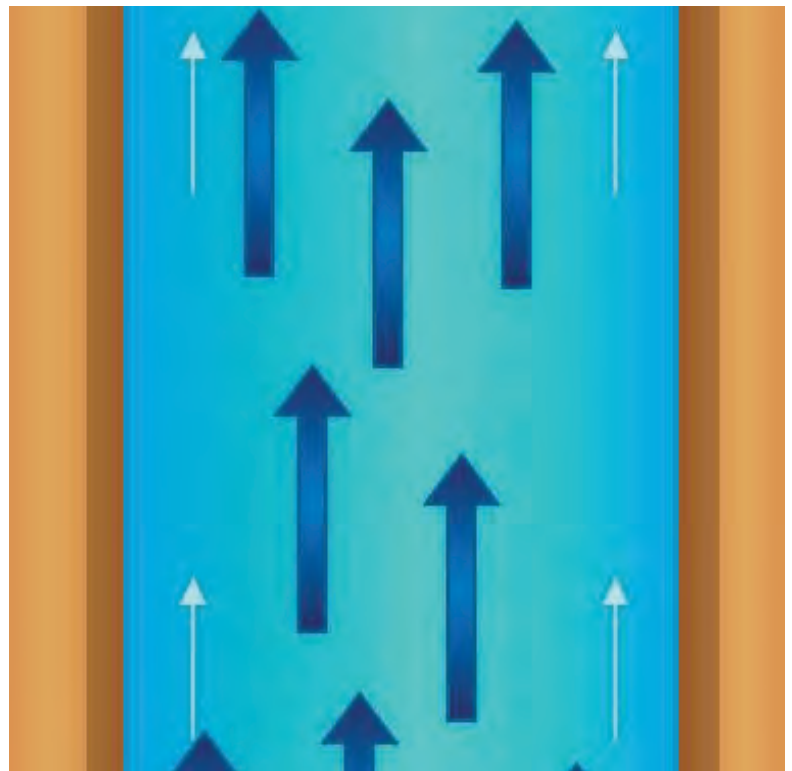

Figure 2-14 — Streamline flow.

If the stream narrows, however, and the volume of flow remains the same, the velocity of flow increases. If the velocity increases sufficiently, the water becomes turbulent (*Figure 2-15*). Swirls, eddies, and cross-motions are set up in the water.

Particles of fluid flowing in pipes act in the same manner. The flow is streamlined if the fluid flows slowly enough, and remains streamlined at greater velocities if the diameter of the pipe is small. The flow of a fluid is turbulent as velocity is increased and the center of flow shifts from the center to the walls of the pipe. Turbulent flow will occur when its velocity is greater than critical velocity. Critical velocity of a fluid is that velocity up to which the fluid flow is streamlined and above which its flow becomes turbulent. When the velocity of a fluid exceeds the critical velocity, the paths and velocities of the fluid particles begin to change continuously and randomly. The flow loses all its orderliness and is called turbulent flow.

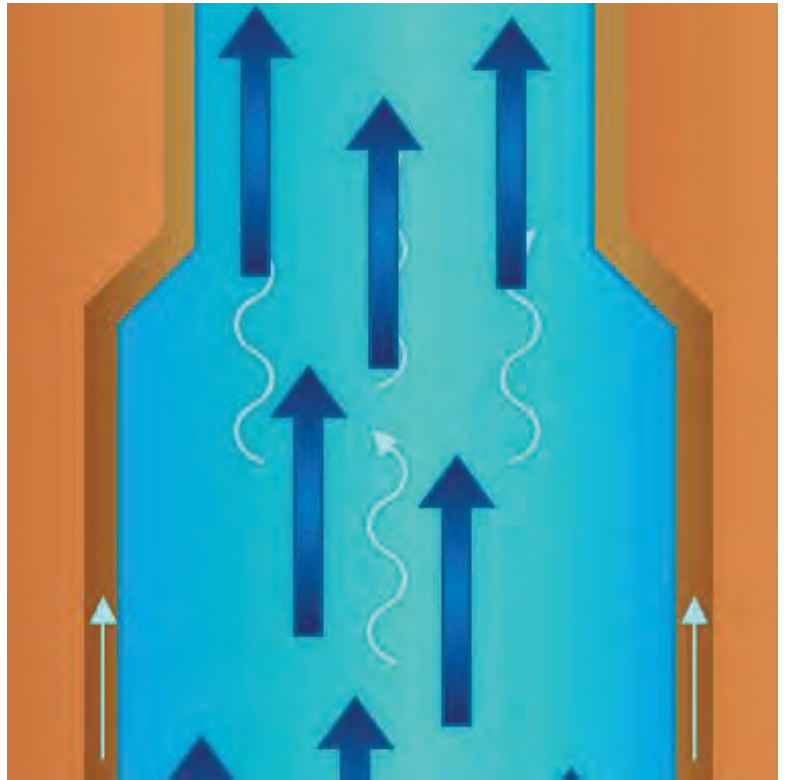

Figure 2-15 — Turbulent flow.

While a high velocity of flow will produce turbulence in any pipe, other factors contribute to turbulence. Among these are the roughness of the inside of the pipe, obstructions, the degree of curvature of bends, and the number of bends in the pipe. In setting up or maintaining fluid power systems, care should be taken to eliminate or minimize as many causes of turbulence as possible, since the energy consumed by turbulence is wasted.

While designers of fluid power equipment do what they can to minimize turbulence, it cannot be avoided. For example, at 68 degrees Fahrenheit (°F), flow becomes turbulent at velocities over approximately 6 inches per second in a 4-inch pipe or about 3 inches per second in a 6-inch pipe. These velocities are far below those commonly encountered in fluid power systems, where velocities of 5 feet per second and above are common. In streamlined flow, losses due to friction increase directly with velocity. With turbulent flow these losses increase much more rapidly.

Factors Involved in Flow

An understanding of the behavior of fluids in motion, or solids for that matter, requires an understanding of the term inertia. Inertia is the term used by scientists to describe the property possessed by all forms of matter that makes the matter resist being moved if it is at rest, and likewise, resist any change in its rate of motion if it is moving.

The basic statement covering inertia is Newton's first law of motion—inertia. Sir Isaac Newton was a British philosopher and mathematician. His first law states: *A body at rest tends to remain at rest, and a body in motion tends to remain in motion at the same speed and direction, unless acted on by some unbalanced force.* This simply says what you have learned by experience—that you must push an object to start it moving and push it in the opposite direction to stop it again.

A familiar illustration is the effort a pitcher must exert to make a fast pitch and the opposition the catcher must put forth to stop the ball. Similarly, considerable work must be performed by the engine

to make an automobile begin to roll; although, after it has attained a certain velocity, it will roll along the road at uniform speed if just enough effort is expended to overcome friction, while brakes are necessary to stop its motion. Inertia also explains the kick or recoil of guns and the tremendous striking force of projectiles.

Inertia and Force

To overcome the tendency of an object to resist any change in its state of rest or motion, some force that is not otherwise canceled or unbalanced must act on the object. Some unbalanced force must be applied whenever fluids are set in motion or increased in velocity; while conversely, forces are made to do work elsewhere whenever fluids in motion are retarded or stopped.

There is a direct relationship between the magnitude of the force exerted and the inertia against which it acts. This force is dependent on two factors: (1) the mass of the object (which is proportional to its weight), and (2) the rate at which the velocity of the object is changed. The rule is that the force in pounds required to overcome inertia is equal to the weight of the object multiplied by the change in velocity, measured in feet per second, and divided by 32 times the time in seconds required to accomplish the change. Thus, the rate of change in velocity of an object is proportional to the force applied. The number 32 appears because it is the conversion factor between weight and mass.

There are five physical factors that can act on a fluid to affect its behavior. All of the physical actions of fluids in all systems are determined by the relationships of these five factors to each other.

Summarizing, these five factors are as follows:

1. Gravity, which acts at all times on all bodies, regardless of other forces.
2. Atmospheric pressure, which acts on any part of a system exposed to the open air.
3. Specific applied forces, which may or may not be present, but which, in any event, are entirely independent of the presence or absence of motion.
4. Inertia, which comes into play whenever there is a change from rest to motion or the opposite, or whenever there is a change in direction or in rate of motion.
5. Friction, which is always present whenever there is motion.

A possible relationship of these factors with respect to a particle of fluid (P) in a system is shown in *Figure 2-16*. The different forces are shown in terms of head, or in other words, in terms of vertical columns of fluid required to provide the forces. At the particular moment under consideration, a particle of water (P) is being acted on by applied force (A), by atmospheric pressure (B), and by gravity (C) produced by the weight of the fluid standing over it. The particle possesses sufficient inertia or velocity head to rise to level P1, since head equivalent to F was lost in friction as P passed through the system. Since atmospheric pressure (B) acts downward on both sides of the system, what is gained on one side is lost on the other.

If all the pressure acting on P to force it through the nozzle could be recovered in the form of elevation head, it would rise to level Y. If account is taken of the balance in atmospheric pressure, in a frictionless system, P would rise to level X, or precisely as high as the sum of the gravity head and the head equivalent to the applied force.

Kinetic Energy

It was previously pointed out that a force must be applied to an object in order to give it a velocity or to increase the velocity it already has. Whether the force begins or changes velocity, it acts over a certain distance. A force acting over a certain distance is work. Work and all forms into which it can be changed are classified as energy. Obviously then, energy is required to give an object velocity. The greater the energy used, the greater the velocity will be.

Disregarding friction, for an object to be brought to rest or for its motion to be slowed down, a force opposed to its motion must be applied to it. This force also acts over some distance. In this way energy is given up by the object and delivered in some form to whatever opposes its continuous motion. The moving object is therefore a means of receiving energy at one place (where its motion is increased) and delivering it to another point (where it is stopped or retarded). While it is in motion, it is said to contain this energy as energy of motion or kinetic energy.

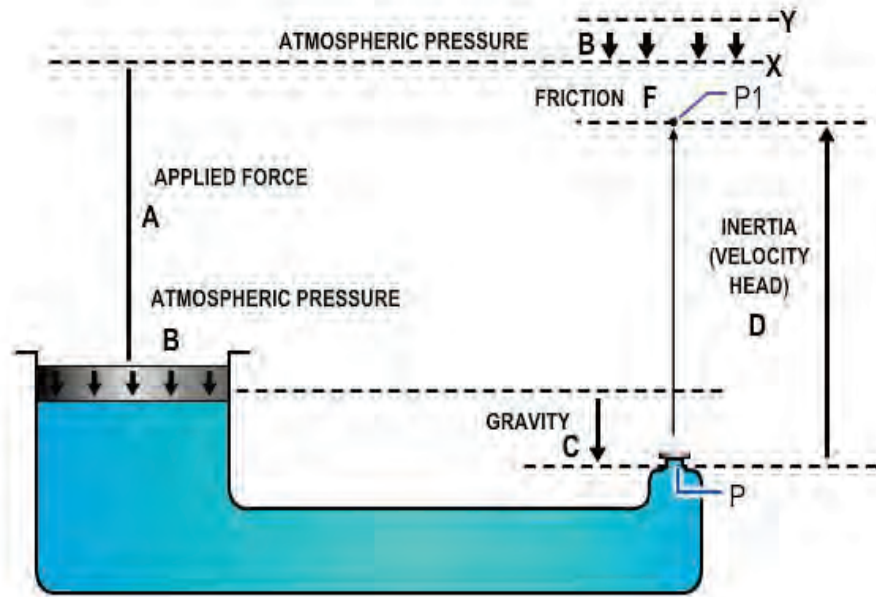

Figure 2-16 — Physical factors governing fluid flow.

Since energy can never be destroyed, it follows that if friction is disregarded the energy delivered to stop the object will exactly equal the energy that was required to increase its speed. At all times the amount of kinetic energy possessed by an object depends on its weight and the velocity at which it is moving.

The mathematical relationship for kinetic energy is stated in the following rule: "Kinetic energy in foot-pounds is equal to the force in pounds which created it, multiplied by the distance through which it was applied, or to the weight of the moving object in pounds, multiplied by the square of its velocity in feet per second, and divided by 64.

The relationship between inertia forces, velocity, and kinetic energy can be illustrated by analyzing what happens when a gun fires a projectile against the armor of an enemy ship (*Figure 2-17*). The explosive force of the powder in the breach pushes the projectile out of the gun, giving it a high velocity. Because of its inertia, the projectile offers opposition to this sudden velocity and a reaction is set up that pushes the gun backward (kick or recoil). The force of the explosion acts on the projectile throughout its movement in the gun. This is force acting through a distance producing work. This work appears as kinetic energy in the speeding projectile. The resistance of the air produces friction, which uses some of the energy and slows down the projectile. Eventually, however, the projectile hits its target and, because of the inertia, tries to continue moving. The target, being relatively stationary, tends to remain stationary because of its inertia. The result is that a tremendous force is set up that either leads to the penetration of the armor or the shattering of the projectile. The projectile is simply a means of transferring energy, in this instance for destructive purpose, from the gun to the enemy ship. This energy is transmitted in the form of energy of motion or kinetic energy.

A similar action takes place in a fluid power system in which the fluid takes the place of the projectile. For example, the pump in a hydraulic system imparts energy to the fluid, which overcomes the inertia of the fluid at rest and causes it to flow through the lines. The fluid flows against some type of actuator that is at rest. The fluid tends to continue flowing, overcomes the inertia of the actuator, and

moves the actuator to do work. Friction uses up a portion of the energy as the fluid flows through the lines and components.

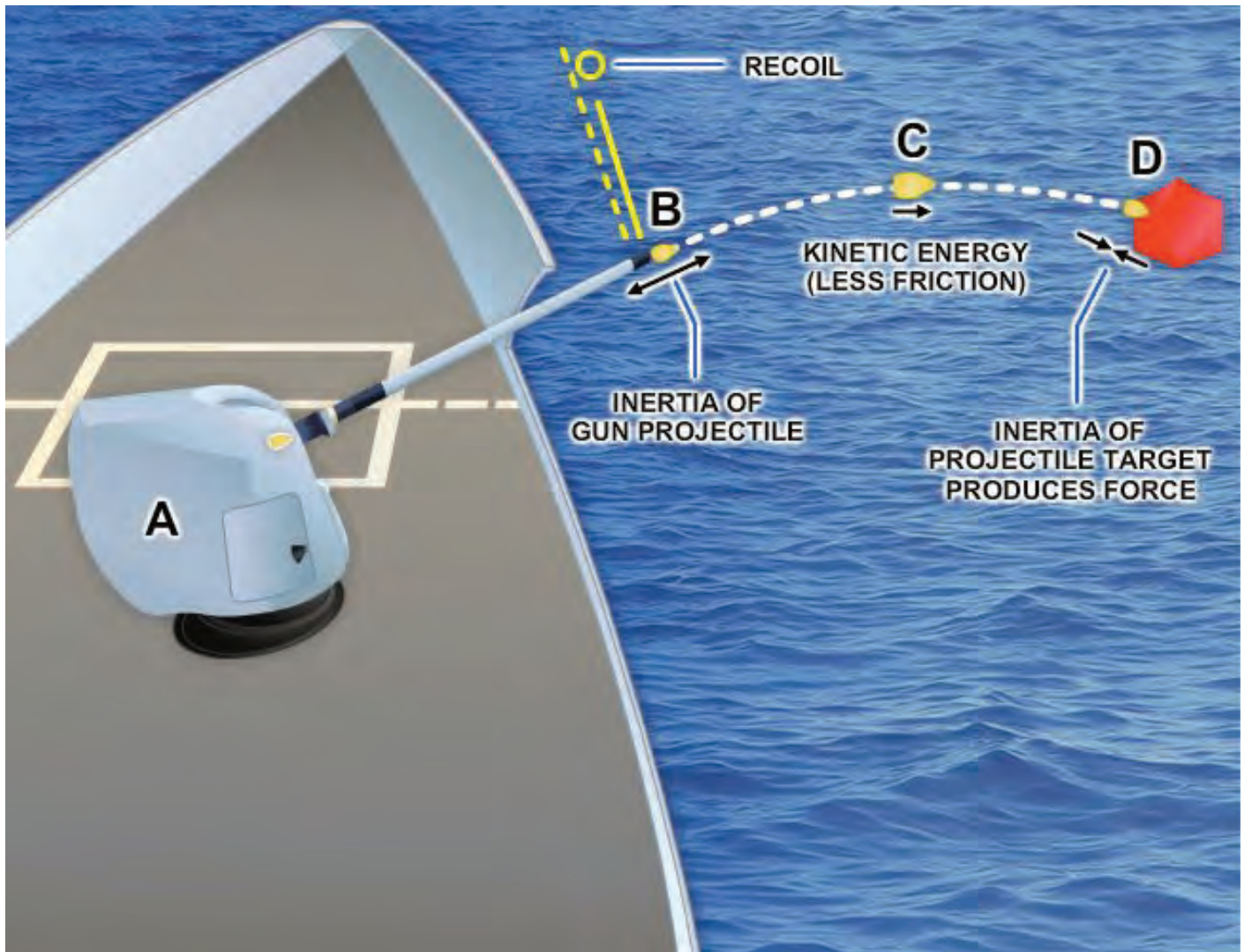

Figure 2-17 — Relationship of inertia, velocity, and kinetic energy.

RELATIONSHIP OF FORCE, PRESSURE, AND HEAD

In dealing with fluids, forces are usually considered in relation to the areas over which they are applied. As previously discussed, a force acting over a unit area is a pressure, and pressure can alternately be stated in pounds per square inch or in terms of head, which is the vertical height of the column of fluid whose weight would produce that pressure.

In most of the applications of fluid power in the Navy, applied forces greatly outweigh all other forces, and the fluid is entirely confined. Under these circumstances it is customary to think of the forces involved in terms of pressures. Since the term head is encountered frequently in the study of fluid power, it is necessary to understand what it means and how it is related to pressure and force.

All five of the factors that control the actions of fluids can, of course, be expressed either as force, or in terms of equivalent pressures or head. In each situation, the different factors are referred to in the same terms, since they can be added and subtracted to study their relationship to each other.

At this point you need to review some terms in general use. Gravity head, when it is important enough to be considered, is sometimes referred to as head. The effect of atmospheric pressure is referred to as atmospheric pressure. (Atmospheric pressure is frequently and improperly referred to as suction.) Inertia effect, because it is always directly related to velocity, is usually called velocity head; and friction, because it represents a loss of pressure or head, is usually referred to as friction head.

Static and Dynamic Factors

Gravity, applied forces, and atmospheric pressure are static factors that apply equally to fluids at rest or in motion, while inertia and friction are dynamic factors that apply only to fluids in motion. The mathematical sum of gravity, applied force, and atmospheric pressure is the static pressure obtained at any one point in a fluid at any given time. Static pressure exists in addition to any dynamic factors that may also be present at the same time.

Remember, Pascal's law states that a pressure set up in a fluid acts equally in all directions and at right angles to the containing surfaces. This covers the situation only for fluids at rest or practically at rest. It is true only for the factors making up static head. Obviously, when velocity becomes a factor it must have a direction, and as previously explained, the force related to the velocity must also have a direction, so that Pascal's law alone does not apply to the dynamic factors of fluid power.

The dynamic factors of inertia and friction are related to the static factors. Velocity head and friction head are obtained at the expense of static head. However, a portion of the velocity head can always be reconverted to static head. Force, which can be produced by pressure or head when dealing with fluids, is necessary to start a body moving if it is at rest, and is present in some form when the motion of the body is arrested; therefore, whenever a fluid is given velocity, some part of its original static head is used to impart this velocity, which then exists as velocity head.

Bernoulli's Principle

Consider the system illustrated in *Figure 2-18*. Chamber A is under pressure and is connected by a tube to chamber B, which is also under pressure. The pressure in chamber A is static pressure of 100 psi. The pressure at some point (X) along the connecting tube consists of a velocity pressure of 10 psi

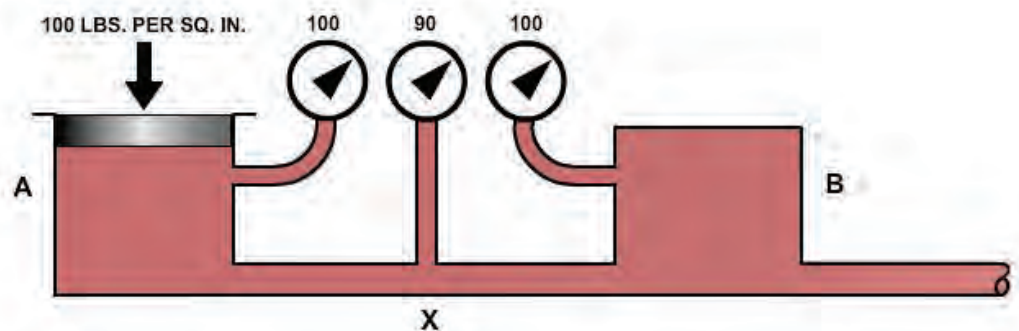

Figure 2-18 — Relationship of static and dynamic factors (Bernoulli's principle).

exerted in a direction parallel to the line of flow, plus the unused static pressure of 90 psi, which still obeys Pascal's law and operates equally in all directions. As the fluid enters chamber B, it is slowed down, and its velocity is changed back to pressure. The force required to absorb its inertia equals the force required to start the fluid moving originally, so that the static pressure in chamber B is equal to that in chamber A.

This situation (*Figure 2-18*) disregards friction; therefore, it would not be encountered in actual practice. Force or head is also required to overcome friction but, unlike inertia effect, this force cannot be recovered again, although the energy represented still exists somewhere as heat. Therefore, in an

actual system the pressure in chamber B would be less than in chamber A by the amount of pressure used in overcoming friction along the way.

At all points in a system the static pressure is always the original static pressure, less any velocity head at the point in question and less the friction head consumed in reaching that point. Since both the velocity head and the friction head represent energy that came from the original static head, and since energy cannot be destroyed, the sum of the static head, the velocity head, and the friction head at any point in the system must add up to the original static head. This is known as Bernoulli's principle, which states: For the horizontal flow of fluid through a tube, the sum of the pressure and the kinetic energy per unit volume of the fluid is constant. This principle governs the relations of the static and dynamic factors concerning fluids, while Pascal's law states the manner in which the static factors behave when taken by themselves.

Minimizing Friction

Fluid power equipment is designed to reduce friction to the lowest possible level. Volume and velocity of flow are made the subject of careful study. The proper fluid for the system is chosen. Clean, smooth pipe of the best dimensions for the particular conditions is used, and it is installed along as direct a route as possible. Sharp bends and sudden changes in cross-sectional areas are avoided. Valves, gauges, and other components are designed to interrupt flow as little as possible. Careful thought is given to the size and shape of the openings. The systems are designed so they can be kept clean inside and variations from normal operation can easily be detected and remedied.

OPERATION OF HYDRAULIC COMPONENTS

To transmit and control power through pressurized fluids, an arrangement of interconnected components is required. Such an arrangement is commonly referred to as a system. The number and arrangement of the components vary from system to system, depending on the particular application. In many applications, one main system supplies power to several subsystems, which are sometimes referred to as circuits. The complete system may be a small compact unit; more often, however, the components are located at widely separated points for convenient control and operation of the system.

The basic components of a fluid power system are essentially the same, regardless of whether the system uses a hydraulic or a pneumatic medium. There are five basic components used in a system. These basic components are as follows:

1. Reservoir or receiver (depending on system type).
2. Pump or compressor.
3. Lines (pipe, tubing, or flexible hose).
4. Directional control valve.
5. Actuating device.

Several applications of fluid power require only a simple system; that is, a system that uses only a few components in addition to the five basic components. A few of these applications are presented in the following paragraphs. We will explain the operation of these systems briefly at this time so you will know the purpose of each component and can better understand how hydraulics is used in the operation of these systems.

Hydraulic Jack

The hydraulic jack is perhaps one of the simplest forms of a fluid power system. By moving the handle of a small device, an individual can lift a load weighing several tons. A small initial force exerted on the handle is transmitted by a fluid to a much larger area. To understand this better, study *Figure 2-19*. The small input piston has an area of 5 square inches and is directly connected to a large cylinder with an output piston having an area of 250 square inches. The top of this piston forms a lift platform.

If a force of 25 pounds is applied to the input piston, it produces a pressure of 5 psi in the fluid, that is, of course, if a sufficient amount of resistant force is acting against the top of the output piston. Disregarding friction loss, this pressure acting on the 250-square-inch area of the output piston will support a resistance force of 1,250 pounds. In other words, this pressure could overcome a force of slightly under 1,250 pounds. An input force of 25 pounds has been transformed into a working force of more than half a ton; however, for this to be true, the distance traveled by the input piston must be 50 times greater than the distance traveled by the output piston. Thus, for every inch that the input piston moves, the output piston will move only one-fiftieth of an inch.

This would be ideal if the output piston needed to move only a short distance. However, in most instances, the output piston would have to be capable of moving a greater distance to serve a practical application. The device shown in *Figure 2-19* is not capable of moving the output piston farther than that shown; therefore, some other means must be used to raise the output piston to a greater height.

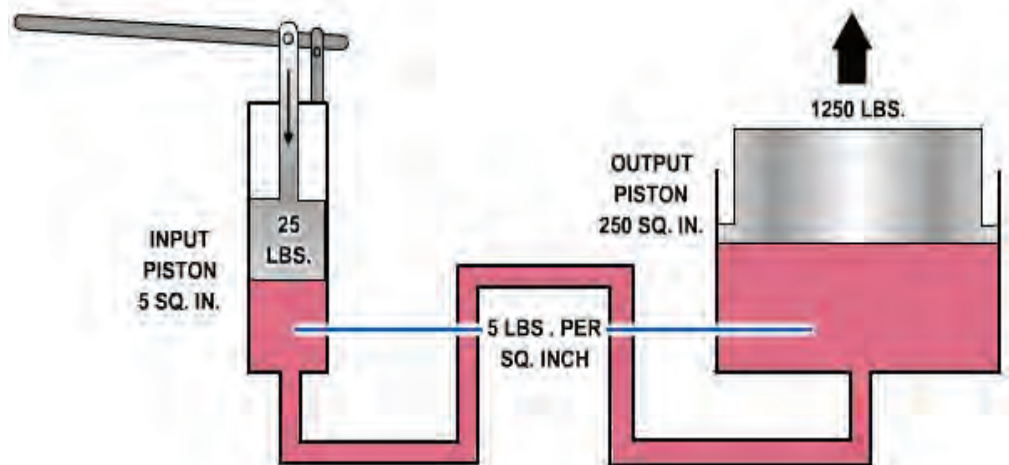

Figure 2-19 — Hydraulic jack.

The output piston can be raised higher and maintained at this height if additional components are installed as shown in *Figure 2-20*. In this illustration the jack is designed so that it can be raised, lowered, or held at a constant height. These results are attained by introducing a number of valves and also a reserve supply of fluid to be used in the system.

Notice that this system contains the five basic components—the reservoir; cylinder 1, which serves as a pump; valve 3, which serves as a directional control valve; cylinder 2, which serves as the actuating device; and lines to transmit the fluid to and from the different components. In addition, this system contains two valves, 1 and 2, whose functions are explained in the following discussion.

As the input piston is raised, valve 1 is closed by the back pressure from the weight of the output piston. At the same time, valve 2 is opened by the head of the fluid in the reservoir. This forces fluid into cylinder 1. When the input piston is lowered, a pressure is developed in cylinder 1. When this pressure exceeds the head in the reservoir, it closes valve 2. When it exceeds the back pressure from the output piston, it opens valve 1, forcing fluid into

the pipeline. The pressure from cylinder 1 is thus transmitted into cylinder 2, where it acts to raise the output piston with its attached lift platform. When the input piston is again raised, the pressure in cylinder 1 drops below that in cylinder 2, causing valve 1 to close. This prevents the return of fluid and holds the output piston with its attached lift platform at its new level. During this stroke, valve 2 opens again, allowing a new supply of fluid into cylinder 1 for the next power (downward) stroke of the input piston. Thus, by repeated strokes of the input piston, the lift platform can be progressively raised. To lower the lift platform, valve 3 is opened, and the fluid from cylinder 2 is returned to the reservoir.

Hydraulic Brakes

The hydraulic brake system used in the automobile is a multiple piston system. A multiple piston system allows forces to be transmitted to two or more pistons in the manner indicated in *Figure 2-21*. Note that the pressure set up by the force applied to the input piston (1) is transmitted undiminished to both output pistons (2 and 3), and that the resultant force on each piston is proportional to its area. The multiplication of forces from the input piston to each output piston is the same as that explained earlier.

The hydraulic brake system from the master cylinders to the wheel cylinders on most automobiles operates in a way similar to the system illustrated in *Figure 2-22*.

When the brake pedal is depressed, the pressure on the brake pedal moves the piston within the master cylinder, forcing the brake fluid from the master cylinder through the tubing and flexible hose to the wheel cylinders. The wheel cylinders contain two opposed output pistons, each of which is attached to a brake shoe fitted inside the brake drum. Each output piston pushes the attached brake shoe against the wall of the brake drum, thus retarding the rotation of the wheel. When pressure on the pedal is released, the springs on

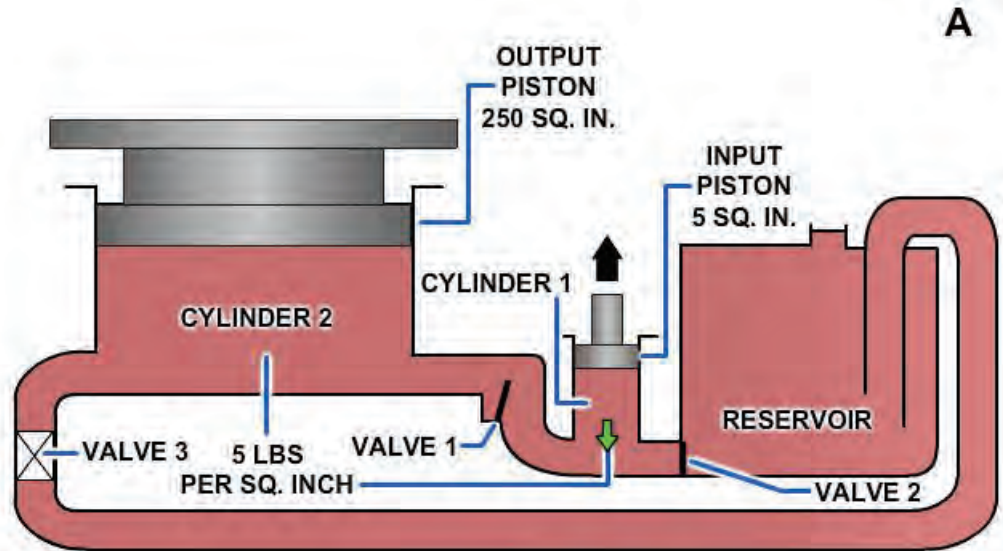

Figure 2-20 — Hydraulic jack; (A) up stroke.

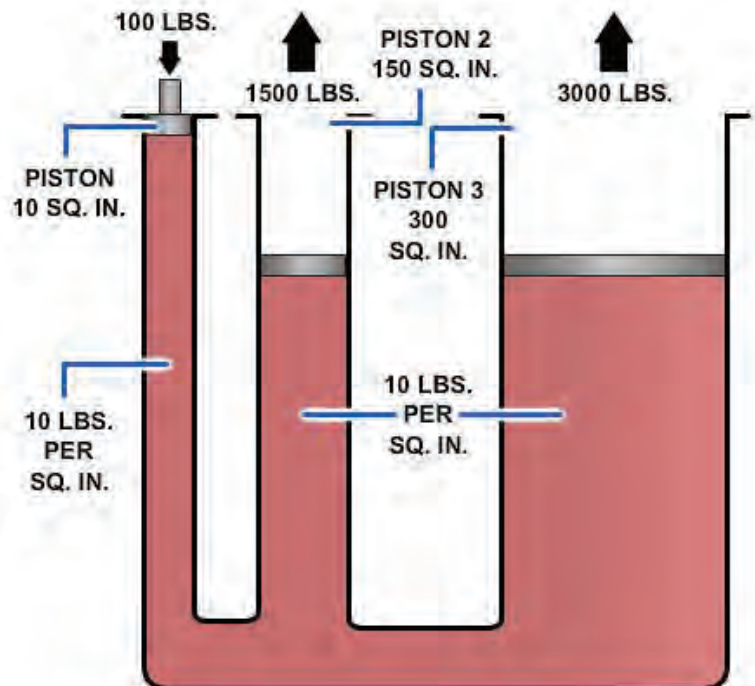

Figure 2-21 — Multiple piston system.

the brake shoes return the wheel cylinder pistons to their released positions. This action forces the displaced brake fluid back through the flexible hose and tubing to the master cylinder.

The force applied to the brake pedal produces a proportional force on each of the output pistons, which in turn apply the brake shoes frictionally to the turning wheels to retard rotation.

As previously mentioned, the hydraulic brake system on most automobiles operates in a similar way, as shown in *Figure 2-22*. It is beyond the scope of this manual to discuss the various brake systems.

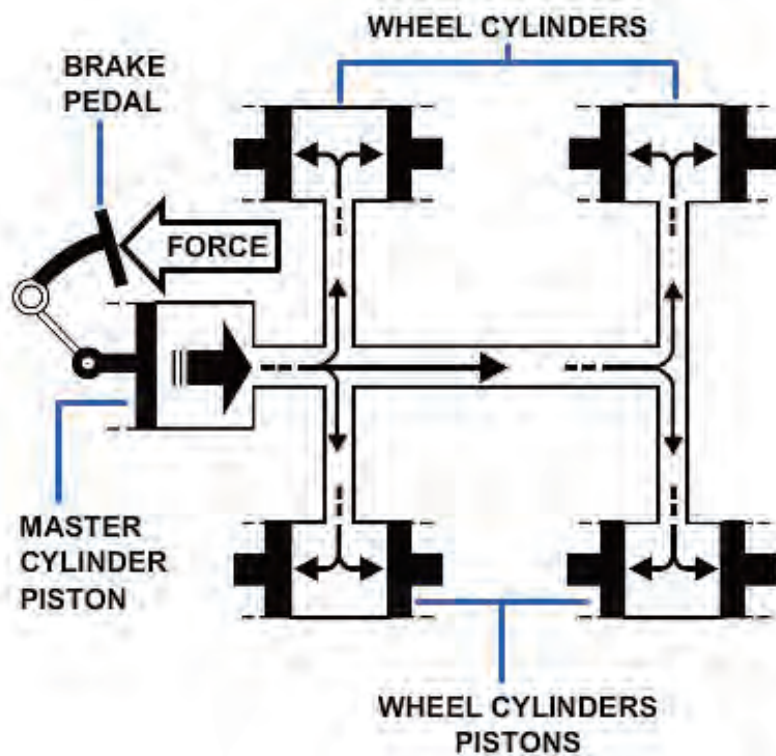

Figure 2-22 — An automobile brake system.

Additional Resources and References:

Airman, NAVEDTRA 14014A, Center for Naval Aviation Technical Training (CNATT), Pensacola, FL, December 2012.

Aviation Structural Mechanic, NAVEDTRA 14315A, Center for Naval Aviation Technical Training (CNATT), Pensacola, FL, March 2011.

Construction Mechanic Basic, NAVEDTRA 14264A, Center for Seabees and Facilities Engineering (CSFE), Port Hueneme, CA, October 2010.

“Hydraulic Equipment (Power Transmission and Control),” *Naval Ships’ Technical Manual (NSTM)*, Chapter 556, Naval Sea Systems Command (NAVSEA), Washington, DC, December 2012.

CHAPTER 3

HYDRAULIC FLUIDS

During the design of equipment that requires fluid power, many factors are considered in selecting the type of system to be used—whether hydraulic, pneumatic, or a combination of the two. Some of the factors include required speed and accuracy of operation, surrounding atmospheric conditions, economic conditions, availability of replacement fluid, required pressure level, operating temperature range, contamination possibilities, cost of transmission lines, limitations of the equipment, lubricity, safety to the operators, and expected service life of the equipment.

After the type of system has been selected, many of these same factors must be considered in selecting the fluid for the system. This chapter is devoted to hydraulic fluids. Included in it are sections on the properties and characteristics desired of hydraulic fluids; types of hydraulic fluids; hazards and safety precautions for working with, handling, and disposing of hydraulic liquids; types and control of contamination; and sampling.

LEARNING OBJECTIVES

When you have completed this chapter, you will be able to do the following:

1. Identify the characteristics of liquid that make it desirable for use in hydraulic systems.
2. Describe the properties and characteristics that must be considered in selecting a hydraulic liquid for a particular system, including related data.
3. Recognize various types of hydraulic liquids and their particular characteristics and uses.
4. Identify types, characteristics, and origin for various hydraulic system contaminants.
5. Describe the controls and checks for various hydraulic system contaminants.

PROPERTIES

If fluidity (the physical property of a substance that enables it to flow) and incompressibility were the only properties required, any liquid not too thick might be used in a hydraulic system. However, a satisfactory liquid for a particular system must possess a number of other properties. The most important properties of hydraulic fluid and some of its characteristics are discussed in the following paragraphs.

Viscosity

Viscosity is one of the most important properties of hydraulic fluids. It is a measure of a fluid's resistance to flow. A liquid that flows easily, such as gasoline, has a low viscosity; and a liquid that flows slowly, such as tar, has a high viscosity. The viscosity of a liquid is affected by changes in temperature and pressure. As the temperature of a liquid increases, its viscosity decreases. That is, a liquid flows more easily when it is hot than when it is cold. The viscosity of a liquid increases as the pressure on the liquid increases.

A satisfactory liquid for a hydraulic system must be thick enough to give a good seal at pumps, motors, valves, and so on. These components depend on close fits for creating and maintaining pressure. Any internal leakage through these clearances results in loss of pressure, instantaneous control, and pump efficiency. Leakage losses are greater with thinner liquids (low viscosity). A liquid that is too thin will also allow rapid wearing of moving parts, or of parts that operate under heavy loads. On the other hand, if the liquid is too thick (viscosity too high), the internal friction of the liquid

will cause an increase in the liquid's flow resistance through clearances of closely fitted parts, lines, and internal passages. This resistance of flow will result in pressure drops throughout the system, sluggish operation of the equipment, and an increase in power consumption.

Measurement of Viscosity

Viscosity is normally determined by measuring the time required for a fixed volume of a fluid (at a given temperature) to flow through a calibrated orifice or capillary tube. The instruments used to measure the viscosity of a liquid are known as viscometers or viscometers.

Several types of viscometers are in use today. The Saybolt viscometer, shown in *Figure 3-1*, measures the time required, in seconds, for 60 milliliters of the tested fluid at 100 degrees Fahrenheit (°F) to pass through a standard orifice. The time measured is used to express the fluid's viscosity, in Saybolt universal seconds or Saybolt furol seconds.

The glass capillary viscometers, shown in *Figure 3-2*, are examples of the second type of viscometer used. These viscometers are used to measure kinematic viscosity. Kinematic viscosity is the ratio of absolute or dynamic viscosity to density—a quantity in which no force is involved.

Kinematic viscosity can be obtained by dividing the dynamic viscosity of a fluid by its density:

$$v = \mu / \rho, \text{ where}$$

v = kinematic viscosity

μ = absolute or dynamic viscosity

ρ = density

Like the Saybolt viscometer, the glass capillary measures the time in seconds required for the tested fluid to flow through the capillary. This time is multiplied by the temperature constant of the viscometer in use to provide the viscosity, expressed in centistokes.

In the International System of Units (SI-system), the theoretical unit is m^2/s or commonly used stoke (St), where:

$$1 \text{ St} = 10^{-4} \text{ m}^2/\text{s}$$

Because the Stoke is an impractical large unit, it is usually divided by 100 to give the unit called centistokes (cSt), where:

$$1 \text{ St} = 100 \text{ cSt}$$

$$1 \text{ cSt} = 10^{-6} \text{ m}^2/\text{s}$$

Because the specific gravity of water at 68.4 °F (20.2 degrees Celsius (°C)) is almost 1, the kinematic viscosity of water at 68.4 °F is, for all practical purposes, 1.0 cSt.

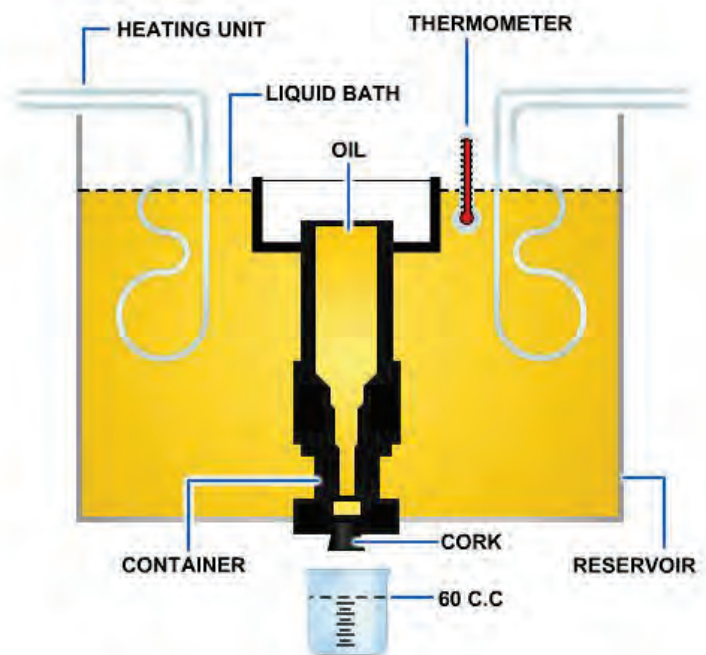

Figure 3-1 — Saybolt viscometer.

The following formulas may be used to convert centistokes (cSt units) to approximate Saybolt universal seconds (SUS units).

For SUS values between 32 and 100:

$$cST = 0.253xSUS - \frac{194.4}{SUS}$$

For SUS values greater than 100:

$$cST = 0.220xSUS - \frac{135}{SUS}$$

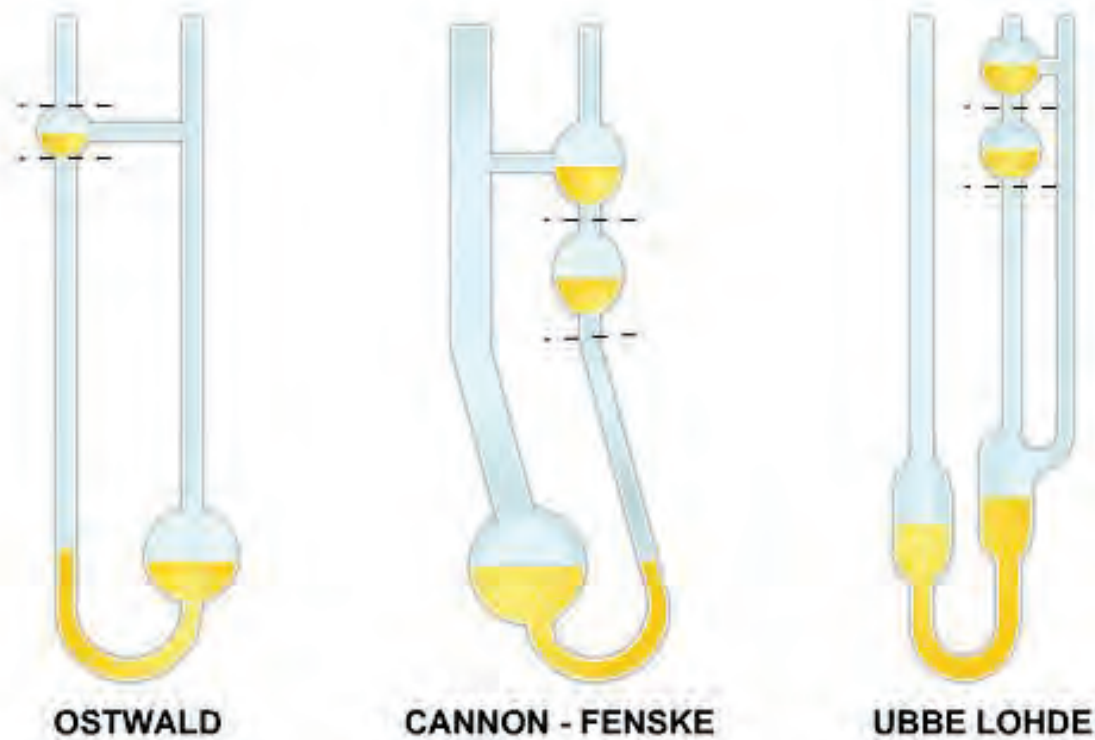

Figure 3-2 — Various styles of glass capillary viscometers.

Although the viscometers discussed above are used in laboratories, other viscometers in the supply system are available for local use. These viscometers can be used to test the viscosity of hydraulic fluids either prior to their being added to a system or periodically after they have been in an operating system for a while.

Refer to the Naval Aircraft Carrier and Amphibious Assault Ships Metrology and Calibration (METCAL) Program Manual, NAVAIR 17-35QAL-15 for additional information on the various types of viscometers and their operation.

Viscosity Index

Viscosity index (VI) is an arbitrary measure for the change of viscosity with variations in temperature. The lower the VI, the greater the change of viscosity of the oil with temperature and vice versa. It is used to characterize viscosity changes with relation to temperature in lubricating oil. The viscosity of liquids decreases as temperature increases. The viscosity of a lubricant is closely related to its ability to reduce friction. Generally, the least viscous lubricant which still forces the two moving surfaces apart is desired. If the lubricant is too viscous, it will require a large amount of energy to move (as in honey); if it is too thin, the surfaces will come in contact and friction will increase.

An ideal oil for most purposes is one that maintains a constant viscosity throughout temperature changes. The importance of the VI can be shown easily by considering automotive lubricants. An oil with a high VI resists excessive thickening when the engine is cold, consequently promoting rapid starting and prompt circulation. It also resists excessive thinning when the motor is hot, thus providing full lubrication and preventing excessive oil consumption.

Another example of the importance of the VI is the need for a high-VI hydraulic oil for military aircraft because hydraulic control systems may be exposed to temperatures ranging from below -65°F at high altitudes to over 100°F on the ground. For the proper operation of the hydraulic control system, the hydraulic fluid must have a sufficiently high VI to perform its functions at the extremes of the expected temperature range.

Liquids with a high viscosity have a greater resistance to heat than low-viscosity liquids, which have been derived from the same source. The average hydraulic liquid has a relatively low viscosity. Fortunately, there is a wide choice of liquids available for use in the viscosity range required of hydraulic liquids.

The VI of an oil may be determined if its viscosity at any two temperatures is known. The American Society for Testing and Materials (ASTM) issues tables that are based on a large number of tests. These tables permit calculation of the VI from known viscosities.

LUBRICATING CHARACTERISTICS

If motion takes place between surfaces in contact, friction tends to oppose the motion. When pressure forces the liquid of a hydraulic system between the surfaces of moving parts, the liquid spreads out into a thin film, which enables the parts to move more freely. Different liquids, including oils, vary greatly not only in their lubricating ability but also in film strength. Film strength is the capability of a liquid to resist being wiped or squeezed out from between the surfaces when spread out in an extremely thin layer. A liquid will no longer lubricate if the film breaks down because the motion of part against part wipes the metal clean of liquid.

Lubricating power varies with temperature changes; therefore, the climatic and working conditions must enter into the determination of the lubricating qualities of a liquid. Unlike viscosity, which is a physical property, the lubricating power and film strength of a liquid is directly related to its chemical nature. Lubricating qualities and film strength can be improved by the addition of certain chemical agents.

CHEMICAL STABILITY

Chemical stability is another property that is exceedingly important in the selection of a hydraulic liquid. It is defined as the liquid's ability to resist oxidation and deterioration for long periods. All liquids tend to undergo unfavorable changes under severe operating conditions.

Excessive temperatures, especially extremely high temperatures, have a great effect on the life of a liquid. The temperature of the liquid in the reservoir of an operating hydraulic system does not always indicate the operating conditions throughout the system. Localized hot spots occur on bearings, on gear teeth, or at other points where the liquid under pressure is forced through small orifices. Continuous passage of the liquid through these points may produce local temperatures high enough to carbonize the liquid or turn it into sludge, yet the liquid in the reservoir may not indicate an excessively high temperature.

Liquids may break down if exposed to air, water, salt, or other impurities, especially if they are in constant motion or subjected to heat. Some metals, such as zinc, lead, brass, and copper, have undesirable chemical reactions with certain liquids.

These chemical reactions result in the formation of sludge, gums, carbon, or other deposits that clog openings, cause valves and pistons to stick or leak, and give poor lubrication to moving parts. Once a small amount of sludge or other deposits is formed, the rate of formation generally increases more rapidly. As these deposits are formed, certain changes in the physical and chemical properties of the liquid take place. The liquid usually becomes darker, the viscosity increases, and damaging acids are formed.

The extent to which changes occur in different liquids depends on the type of liquid, type of refining, and whether it has been treated to provide further resistance to oxidation. The stability of liquids can be improved by the addition of oxidation inhibitors. Inhibitors selected to improve stability must be compatible with the other required properties of the liquid.

ACIDITY

An ideal hydraulic liquid should be free from acids that cause corrosion of the metals in the system. Most liquids cannot be expected to remain completely noncorrosive under severe operating conditions. The degree of acidity of a liquid, when new, may be satisfactory; but after use, the liquid may tend to become corrosive as it begins to deteriorate.

Many systems are idle for long periods after operating at high temperatures. This permits moisture to condense in the system, resulting in rust formation.

Certain corrosion- and rust-preventive additives are added to hydraulic liquids. Some of these additives are effective only for a limited period. Therefore, the best procedure is to use the liquid specified for the system for the time specified by the system manufacturer and to protect the liquid and the system as much as possible from contamination by foreign matter, from abnormal temperatures, and from misuse.

FLASHPOINT

Flashpoint is the temperature at which a liquid gives off vapor in sufficient quantity to ignite momentarily or flash when a flame is applied. A high flashpoint is desirable for hydraulic liquids because it provides good resistance to combustion and a low degree of evaporation at normal temperatures. Required flashpoint minimums vary from 300 °F for the lightest oils to 510 °F for the heaviest oils.

FIRE POINT

Fire point is the temperature at which a substance gives off vapor in sufficient quantity to ignite and continue to burn when exposed to a spark or flame. Like flashpoint, a high fire point is required of desirable hydraulic liquids.

TOXICITY

Toxicity is defined as the quality, state, or degree of being toxic or poisonous. Some liquids contain chemicals that are a serious toxic hazard. These toxic or poisonous chemicals may enter the body through inhalation, by absorption through the skin, or through the eyes or the mouth. The result is sickness and, in some cases, death. Manufacturers of hydraulic liquids strive to produce suitable liquids that contain no toxic chemicals. As a result, most hydraulic liquids are free of harmful chemicals. Some fire-resistant liquids are toxic, and suitable protection and care in handling must be provided.

DENSITY AND COMPRESSIBILITY

A fluid with a specific gravity of less than 1.0 is desired when weight is critical, although with proper system design, a fluid with a specific gravity greater than 1 can be tolerated. Where avoidance of detection by military units is desired, a fluid that sinks rather than rises to the surface of the water is desirable. Fluids having a specific gravity greater than 1.0 are desired because leaking fluid will sink, allowing the vessel with the leak to remain undetected.

Under extreme pressure, a fluid may be compressed up to 7 percent of its original volume. Highly compressible fluids produce sluggish system operation. This effect does not present a serious problem in small, low-speed operations, but it must be considered in the operating instructions.

FOAMING

Foam is an emulsion of gas bubbles in the fluid. Foam in a hydraulic system results from compressed gases in the hydraulic fluid. A fluid under high pressure can contain a large volume of air bubbles. When this fluid is depressurized, as when it reaches the reservoir, the gas bubbles in the fluid expand and produce foam. Any amount of foaming may cause pump cavitation and produce poor system response and spongy control. Therefore, defoaming agents are often added to fluids to prevent foaming. Minimizing air in fluid systems is discussed later in this chapter.

CLEANLINESS

Cleanliness in hydraulic systems has received considerable attention recently. Some hydraulic systems, such as aerospace hydraulic systems, are extremely sensitive to contamination. Fluid cleanliness is of primary importance because contaminants can cause component malfunction, prevent proper valve seating, cause wear in components, and increase the response time of servo valves. Fluid contaminants are discussed later in this chapter.

The inside of a hydraulic system can only be kept as clean as the fluid added to it. Initial fluid cleanliness can be achieved by observing stringent cleanliness requirements (discussed later in this chapter) or by filtering all fluid added to the system.

TYPES OF HYDRAULIC FLUIDS

Many liquids have been tested for use in hydraulic systems. Currently, liquids being used include mineral oil, water, phosphate ester, water-based ethylene glycol compounds, and silicone fluids. The three most common types of hydraulic liquids are petroleum-based, synthetic fire-resistant, and water-based fire-resistant.

Petroleum-Based Fluids

The most common hydraulic fluids used in shipboard systems are the petroleum-based oils. These fluids contain additives to protect the fluid from oxidation (antioxidant), to protect system metals from corrosion (anticorrosion), to reduce tendency of the fluid to foam (foam suppressant), and to improve viscosity.

Petroleum-based fluids are used in surface ships' electrohydraulic steering and deck machinery systems; submarines' hydraulic systems; and aircraft automatic pilots, shock absorbers, brakes, control mechanisms, and other hydraulic systems using seal materials compatible with petroleum-based fluids.

Synthetic Fire-Resistant Fluids

Petroleum-based oils contain most of the desired properties of a hydraulic liquid. However, they are flammable under normal conditions and can become explosive when subjected to high pressures and a source of flame or high temperatures. Nonflammable synthetic liquids have been developed for use in hydraulic systems where fire hazards exist.

Phosphate Ester Fire-Resistant Fluid

Phosphate ester fire-resistant fluid for shipboard use is covered by specification MIL-H-19457. Tertiary butylated triphenyl phosphate fluids per MIL-H-19457 have been used in aircraft elevators and other surface ship hydraulic systems where a fire-resistant fluid is required. These fluids will be delivered in containers marked MIL-H-19457C or a later specification revision. Phosphate ester in containers marked by a brand name without a specification identification must not be used in shipboard systems because they may contain toxic chemicals.

These fluids will burn if sufficient heat and flame are applied, but they do not support combustion. Drawbacks of phosphate ester fluids are that they will attack and loosen commonly used paints and adhesives, deteriorate many types of insulations used in electrical cables, and deteriorate many gasket and seal materials. Therefore, specific materials are used to manufacture gaskets and seals for systems in which phosphate ester fluids are used. Naval Ships' Technical Manual (NSTM), chapter 556, specifies paints to be used on exterior surfaces of hydraulic systems and components in which phosphate ester fluid is used and on ship structure and decks in the immediate vicinity of this equipment. NSTM, chapter 078, specifies gasket and seal materials used. The Aviation Hydraulics Manual, NAVAIR 01-1A-17 also contains a list of materials resistant to phosphate ester fluids.

Trade names for phosphate ester fluids that do not conform to MIL-H-19457 include Pydraul, Skydrol, and Fyre Safe.

Phosphate Ester Fluid Safety

As a maintenance person, operator, supervisor, or crew member of a ship, squadron, or naval shore installation, you must understand the hazards associated with hydraulic fluids to which you may be exposed.

Phosphate ester fluid conforming to specification MIL-H-19457 is used in aircraft elevators, ballast valve operating systems, and replenishment-at-sea systems. This type of fluid contains a controlled amount of neurotoxic material. Because of the neurotoxic effects that can result from ingestion, skin absorption, or inhalation of these fluids, be sure to use the following precautions:

1. Avoid contact with the fluids by wearing protective clothing.
2. Use chemical goggles or face shields to protect your eyes.
3. If you are expected to work in an atmosphere containing a fine mist or spray, wear a continuous-flow airline respirator.
4. Thoroughly clean skin areas contaminated by this fluid with soap and water.
5. If you get any fluid in your eyes, flush them with running water for at least 15 minutes and seek medical attention.

If you come in contact with MIL-H-19457 fluid, report the contact when you seek medical aid and whenever you have a routine medical examination.

NSTM, chapter 556, contains a list of protective clothing, along with national stock numbers (NSNs), for use with fluids conforming to MIL-H-19457. It also contains procedures for repair work and for low-level leakage and massive spills cleanup.

Phosphate Ester Fluid Disposal

Waste fluids and refuse (rags and other materials) must not be dumped at sea. Fluid should be placed in bung-type drums. Rags and other materials should be placed in open-top drums for shore disposal. These drums should be marked with a warning label stating their content, safety precautions, and disposal instructions. Refer to NSTM chapter 556 and OPNAVINST 5090.1, Environmental Readiness Program Manual for detailed instructions on phosphate ester fluids disposal.

Synthetic Fire-Resistant Fluids (Silicone)

Synthetic fire-resistant fluids are frequently used for hydraulic systems that require fire resistance but have only marginal requirements for other chemical or physical properties common to hydraulic fluids. Silicone fluids do not have the detrimental characteristics of phosphate ester fluids, nor do they provide the corrosion protection and lubrication of phosphate ester fluids, but they are excellent for fire protection. Silicone fluid conforming to MIL-S-81087 is used in the missile holddown and lockout system aboard submarines.

Lightweight Synthetic Fire-Resistant Fluids

In applications where weight is critical, lightweight synthetic fluid is used in hydraulic systems. MIL-H-83282 is a synthetic, fire-resistant hydraulic fluid used in military aircraft and hydrofoils where the requirement to minimize weight dictates the use of a low-viscosity fluid. It is also the most commonly used fluid in aviation support equipment. NAVAIR 01-1A-17 contains additional information on fluids conforming to specification MIL-H-83282.

Water-Based Fire-Resistant Fluids

The most widely used water-based hydraulic fluids may be classified as water-glycol mixtures and water-synthetic base mixtures. The waterglycol mixture contains additives to protect it from oxidation, corrosion, and biological growth and to enhance its load-carrying capacity.

Fire resistance of the water mixture fluids depends on the vaporization and smothering effect of steam generated from the water. The water in water-based fluids is constantly being driven off while the system is operating. Therefore, frequent checks to maintain the correct ratio of water are important.

The water-based fluid used in aircraft handling machinery (catapults), catapult retracting engines, and jet blast deflectors conforms to MIL-H-22072.

The safety precautions outlined for phosphate ester fluid and the disposal of phosphate ester fluid also apply to water-based fluid conforming to MIL-H-22072.

CONTAMINATION

Hydraulic fluid contamination may be described as any foreign material or substance whose presence in the fluid is capable of adversely affecting system performance or reliability. It may assume many different forms, including liquids, gases, and solid matter of various compositions, sizes, and shapes. Solid matter is the type most often found in hydraulic systems and is generally referred to as particulate contamination. Contamination is always present to some degree, even in new, unused fluid, but must be kept below a level that will adversely affect system operation. Hydraulic contamination control consists of requirements, techniques, and practices necessary to minimize and control fluid contamination.

Classification

Many types of contaminants are harmful to hydraulic systems and liquids. These contaminants may be divided into two different classes—particulate and fluid.

Particulate Contamination

This class of contaminants includes organic, metallic solid, and inorganic solid contaminants. These contaminants are discussed in the following paragraphs.

Organic Contamination

Organic solids or semisolids found in hydraulic systems are produced by wear, oxidation, or polymerization. Minute particles of O-rings, seals, gaskets, and hoses are present due to wear or chemical reactions. Synthetic products, such as neoprene, silicones, and hypalon, though resistant to chemical reaction with hydraulic fluids, produce small wear particles. Oxidation of hydraulic fluids increases with pressure and temperature, although antioxidants are blended into hydraulic fluids to minimize such oxidation. The ability of a hydraulic fluid to resist oxidation or polymerization in service is defined as its oxidation stability. Oxidation products appear as organic acids, asphaltics, gums, and varnishes. These products combine with particles in the hydraulic fluid to form sludge. Some oxidation products are oil soluble and cause the hydraulic fluid to increase in viscosity; other oxidation products are not oil soluble and form sediment.

Metallic Solid Contamination

Metallic contaminants are almost always present in a hydraulic system and will range in size from microscopic particles to particles readily visible to the naked eye. These particles are the result of wearing and scoring of bare metal parts and plating materials, such as silver and chromium. Although practically all metals commonly used for parts fabrication and plating may be found in hydraulic fluids, the major metallic materials found are ferrous, aluminum, and chromium particles. Because of their continuous high-speed internal movement, hydraulic pumps usually contribute most of the metallic particulate contamination present in hydraulic systems. Metal particles are also produced by other hydraulic system components, such as valves and actuators, due to body wear and the chipping and wearing away of small pieces of metal plating materials.

Inorganic Solid Contamination

This contaminant group includes dust, paint particles, dirt, and silicates. Glass particles from glass bead peening and blasting may also be found as contaminants. Glass particles are very undesirable contaminants due to their abrasive effect on synthetic rubber seals and the very fine surfaces of critical moving parts. Atmospheric dust, dirt, paint particles, and other materials are often drawn into hydraulic systems from external sources. For example, the wet piston shaft of a hydraulic actuator may draw some of these foreign materials into the cylinder past the wiper and dynamic seals, and the contaminant materials are then dispersed in the hydraulic fluid. Contaminants may also enter the hydraulic fluid during maintenance when tubing, hoses, fittings, and components are disconnected or replaced. It is therefore important that all exposed fluid ports be sealed with approved protective closures to minimize such contamination.

Fluid Contamination

Air, water, solvent, and other foreign fluids are in the class of fluid contaminants.

Air Contamination

Hydraulic fluids are adversely affected by dissolved, entrained, or free air. Air may be introduced through improper maintenance or as a result of system design. Any maintenance operation that involves breaking into the hydraulic system, such as disconnecting or removing a line or component, will invariably result in some air being introduced into the system. This source of air can and must be minimized by prefilling replacement components with new filtered fluid prior to their installation. Failing to prefill a filter element bowl with fluid is a good example of how air can be introduced into the system. Although prefilling will minimize introduction of air, it is still important to vent the system where venting is possible.

Most hydraulic systems have built-in sources of air. Leaky seals in gas-pressurized accumulators and reservoirs can feed gas into a system faster than it can be removed, even with the best of maintenance. Another lesser known but major source of air is air that is sucked into the system past actuator piston rod seals. This usually occurs when the piston rod is stroked by some external means while the actuator itself is not pressurized.

Water Contamination

Water is a serious contaminant of hydraulic systems. Hydraulic fluids are adversely affected by dissolved, emulsified, or free water. Water contamination may result in the formation of ice, which impedes the operation of valves, actuators, and other moving parts. Water can also cause the formation of oxidation products and corrosion of metallic surfaces.

Solvent Contamination

Solvent contamination is a special form of foreign-fluid contamination in which the original contaminating substance is a chlorinated solvent. Chlorinated solvents or their residues may, when introduced into a hydraulic system, react with any water present to form highly corrosive acids.

Chlorinated solvents, when allowed to combine with minute amounts of water often found in operating hydraulic systems, change chemically into hydrochloric acids. These acids then attack internal metallic surfaces in the system, particularly those that are ferrous, and produce a severe rustlike corrosion. NAVAIR 01-1A-17 and NSTM, chapter 556, contain tables of solvents for use in hydraulic maintenance.

Foreign-Fluids Contamination

Hydraulic systems can be seriously contaminated by foreign fluids other than water and chlorinated solvents. This type of contamination is generally a result of lube oil, engine fuel, or incorrect hydraulic fluid being introduced inadvertently into the system during servicing. The effects of such contamination depend on the contaminant, the amount in the system, and how long it has been present.

NOTE

It is extremely important that the different types of hydraulic fluids are not mixed in one system. If different type hydraulic fluids are mixed, the characteristics of the fluid required for a specific purpose are lost. Mixing the different types of fluids usually will result in a heavy, gummy deposit that will clog passages and require a major cleaning. In addition, seals and packing installed for use with one fluid usually are not compatible with other fluids, and damage to the seals will result.

Origin of Contamination

Recall that contaminants are produced from wear and chemical reactions, introduced by improper maintenance, and inadvertently introduced during servicing. These methods of contaminant introduction fall into one of the four major areas of contaminant origin.

Particles Originally Contained in the System

These particles originate during the fabrication and storage of system components. Weld spatter and slag may remain in welded system components, especially in reservoirs and pipe assemblies. The presence is minimized by proper design. For example, seam-welded overlapping joints are preferred, and arc welding of open sections is usually avoided. Hidden passages in valve bodies, inaccessible to sand blasting or other methods of cleaning, are the main source of introduction of core sand. Even the most carefully designed and cleaned casting will almost invariably free some sand particles under the action of hydraulic pressure. Rubber hose assemblies always contain some loose particles. Most of these particles can be removed by flushing the hose before installation; however, some particles withstand cleaning and are freed later by the action of hydraulic pressure.

Particles of lint from cleaning rags can cause abrasive damage in hydraulic systems, especially to closely fitted moving parts. In addition, lint in a hydraulic system packs easily into clearances between packing and contacting surfaces, leading to component leakage and decreased efficiency. Lint also helps clog filters prematurely. The use of the proper wiping materials will reduce or eliminate lint contamination. The wiping materials to be used for a given application will be determined by:

- Substances being wiped or absorbed
- The amount of absorbency required
- The required degree of cleanliness

These wiping materials are categorized for contamination control by the degree of lint or debris that they may deposit during use. For internal hydraulic repairs, this factor itself will determine the choice of wiping material. NAVAIR 01-1A-17 and NSTM, chapter 556, provide information on low-lint wiping cloths.

Rust or corrosion initially present in a hydraulic system can usually be traced to improper storage of materials and component parts. Particles can range in size from large flakes to abrasives of microscopic dimensions. Proper preservation of stored parts is helpful in eliminating corrosion.

Particles Introduced from Outside Sources

Particles can be introduced into hydraulic systems at points where either the liquid or certain working parts of the system (for example, piston rods) are at least in temporary contact with the atmosphere.

The most common contaminant introduction areas are at the refill and breather openings, cylinder rod packings, and open lines where components are removed for repair or replacement. Contamination arising from carelessness during servicing operations is minimized by the use of filters in the system fill lines and finger strainers in the filler adapter of hydraulic reservoirs. Hydraulic cylinder piston rods incorporate wiper rings and dust seals to prevent the dust that settles on the piston rod during its outward stroke from entering the system when the piston rod retracts. Caps and plugs are available and should be used to seal off the open lines when a component is removed for repair or replacement.

Particles Created Within the System During Operation

Contaminants created during system operation are of two general types—mechanical and chemical. Particles of a mechanical nature are formed by the wearing of parts in frictional contact, such as pumps, cylinders, and packing gland components. These wear particles can vary from large chunks of packings down to steel shavings that are too small to be trapped by filters.

The major source of chemical contaminants in hydraulic liquid is oxidation. These contaminants are formed under high pressure and temperatures and are promoted by the chemical action of water and air and of metals such as copper and iron oxides. Liquid-oxidation products appear initially as organic acids, asphaltines, gums, and varnishes—sometimes combined with dust particles as sludge. Liquid-soluble oxidation products tend to increase liquid viscosity, while insoluble types separate and form sediments, especially on colder elements such as heat exchanger coils.

Liquids containing antioxidants have little tendency to form gums and sludge under normal operating conditions. However, as the temperature increases, resistance to oxidation diminishes. Hydraulic liquids that have been subjected to excessively high temperatures (above 250 °F for most liquids) will break down, leaving minute particles of asphaltines suspended in the liquids. The liquid changes to brown in color and is referred to as decomposed liquid. This process explains the importance of keeping the hydraulic liquid temperature below specific levels.

The second contaminant-producing chemical action in hydraulic liquids is one that permits these liquids to react with certain types of rubber. This reaction causes structural changes in the rubber, turning it brittle and finally causing its complete disintegration. For this reason, the compatibility of system liquid with seals and hose material is a very important factor.

Particles Introduced by Foreign Liquids

One of the most common foreign-fluid contaminants is water, especially in hydraulic systems that require petroleum-based liquids. Water, which enters even the most carefully designed system by condensation of atmospheric moisture, normally settles to the bottom of the reservoir. Oil movement in the reservoir disperses the water into fine droplets, and agitation of the liquid in the pump and in high-speed passages forms an oil-water-air emulsion. This emulsion normally separates during the rest period in the system reservoir; but when fine dust and corrosion particles are present, the emulsion is chemically changed by high pressures into sludge. The damaging action of sludge explains the need for effective filtration, as well as the need for water separation qualities in hydraulic liquids.

Contamination Control

Maintaining hydraulic fluid within allowable contamination limits for both water and particulate matter is crucial to the care and protection of hydraulic equipment.

Filters will provide adequate control of the particular contamination problem during all normal hydraulic system operations if the filtration system is installed properly and filter maintenance is performed properly. Filter maintenance includes changing elements at proper intervals. Control of the

size and amount of contamination entering the system from any other source is the responsibility of the personnel who service and maintain the equipment. During installation, maintenance, and repair of hydraulic equipment, the retention of cleanliness of the system is of paramount importance for subsequent satisfactory performance.

Adhere to the following maintenance and servicing procedures at all times to provide proper contamination control:

1. Keep all tools and the work area (workbenches and test equipment) in a clean, dirt-free condition.
2. Ensure a suitable container is always provided to receive the hydraulic liquid that is spilled during component removal or disassembly.

NOTE

After draining liquid from these systems for reuse, store it in a clean and suitable container. Strain and/or filter the liquid when returning it to the system reservoir.

3. Before disconnecting hydraulic lines or fittings, clean the affected area with an approved dry-cleaning solvent.
4. Cap or plug all hydraulic lines and fittings immediately after disconnection.
5. Before assembling any hydraulic components, wash their parts with an approved dry-cleaning solvent.
6. After cleaning the parts in dry-cleaning solvent, dry them thoroughly with clean, low-lint cloths and lubricate with the recommended preservative or hydraulic liquid before assembling.

NOTE

Only use clean, low-lint type I or II cloths as appropriate to wipe or dry component parts.

7. Replace all packings and gaskets during the assembly procedures.
8. Connect all parts with care to avoid stripping metal slivers from threaded areas. Install and torque all fittings and lines according to applicable technical instructions.
9. Keep all hydraulic servicing equipment clean and in good operating condition.

Some hydraulic fluid specifications, such as MIL-H-6083, MIL-H-46170, and MIL-H-83282, contain particle contamination limits that are so low that the products are packaged under clean room conditions. Very slight amounts of dirt, rust, and metal particles will cause them to fail the specification limit for contamination. Because these fluids are usually all packaged in hermetically sealed containers, the act of opening a container may allow more contaminants into the fluid than the specification allows. Therefore, take extreme care in the handling of these fluids. In opening the container for use, observation, or tests, it is extremely important to open and handle the can in a clean environment. Flush the area of the container to be opened with filtered solvent (petroleum ether or isopropyl alcohol), and thoroughly rinse the device used for opening the container with filtered solvent. After opening the container, pour a small amount of the material from the container and disposed of it before pouring the sample for analysis. Once you have opened a container, if the contents are not totally used, discard the unused portion. Because the level of contamination of a system containing these fluids must be kept low, perform maintenance on the system's components

in a clean environment commonly known as a controlled environment work center. Refer to Aviation Hydraulics Manual, NAVAIR 01-1A-17, for specific information about the controlled environment work center.

Hydraulic Fluid Sampling

The condition of a hydraulic system, as well as its probable future performance, can best be determined by analyzing the operating fluid. Of particular interest are any changes in the physical and chemical properties of the fluid and excessive particulate or water contamination, either of which indicates impending trouble. Excessive particulate contamination of the fluid indicates that the filters are not keeping the system clean. This impediment can result from improper filter maintenance, inadequate filters, or excessive ongoing corrosion and wear.

Sample operating equipment according to instructions given in the operating and maintenance manual for the particular equipment or as directed by the Maintenance Requirement Cards (MRCs).

1. Take all samples from circulating systems, or immediately upon shutdown, while the hydraulic fluid is within 5 °C (9 °F) of normal system operating temperature. Systems not up to temperature may provide nonrepresentative samples of system dirt and water content. Discard the first oil coming from the sampling point because it can be dirty and does not represent the system. Either avoid such samples or indicate the status on the analysis report. As a general rule, a volume of oil equivalent to one to two times the volume of oil contained in the sampling line and valve should be drained before the sample is taken.
2. Ideally, take the sample from a valve installed specifically for sampling. When sampling valves are not installed, avoid taking samples from locations where sediment or water can collect, such as dead ends of piping, tank drains, and low points of large pipes and filter bowls, if possible. If taking samples from pipe drains, drain sufficient fluid before taking the sample to ensure that the sample actually represents the system. Do not take samples from the tops of reservoirs or other locations where the contamination levels are normally low.
3. Unless otherwise specified, take a minimum of one sample for each system located wholly within one compartment. For ships' systems extending into two or more compartments, a second sample is required. An exception to this requirement is submarine external hydraulic systems, which require only one sample. Original sample points should be labeled and the same sample points used for successive sampling. If possible, the following sampling locations should be selected: Label original sample points, and use the same sample points for successive sampling. If possible, select the following sampling locations:
 - a. A location that provides a sample representative of fluid being supplied to system components
 - b. A return line as close to the supply tank as practical but upstream of any return line filter
 - c. For systems requiring a second sample, a location as far from the pump as practical

Operation of the sampling point should not introduce any significant amount of external contaminants into the collected fluid. For additional information on hydraulic fluid sampling, refer to NAVAIR 01-1A-17.

Most fluid samples are submitted to shore laboratories for analysis. Refer to NAVAIR 17-15-50-1, NSTM chapter 556, and NSTM 226 for additional information on collection, labeling, and shipping samples.

Additional Resources and References:

“Afloat Hazardous Material Control and Management Guidelines Hazardous Material Users Guide (HMUG),” *Naval Ships’ Technical Manual (NSTM)*, Chapter 670, Volume 2, Naval Sea Systems Command, Washington, DC, June 2012.

Aviation Hydraulics Manual, NAVAIR 01-1A-17, Commander, Naval Air Systems Command, Patuxent River, MD, August 2008.

Environmental Readiness Program, OPNAVINST 5090.1(series), Chief of Naval Operations, Washington, DC, 10 January 2014.

“Gaskets and Packing,” *Naval Ships’ Technical Manual (NSTM)*, Chapter 078, Volume 2, Naval Sea Systems Command (NAVSEA), Washington, DC, September 1998.

“Hydraulic Equipment (Power Transmission and Control),” *Naval Ships’ Technical Manual (NSTM)*, Chapter 556, Naval Sea Systems Command (NAVSEA), Washington, DC, December 2012.

Navy Safety and Occupational Health (SOH) Program Manual for Forces Afloat, OPNAVINST 5100.19(series), Volume 1, Chief of Naval Operations, Washington, DC, May 2007.